

Prepp

Your Personal Exams Guide



NDA



CDS



SSC CGL



CBSE UGC NET



IAS



SSC CHSL



CTET



MPSC



AFCAT



CSIR UDC NET



IBPS PO



UP POLICE



SSC MTS



SBI PO



BPS



UPTET



IBPS RRB



IBPS CLERK



IES



UPSC CAPF



SSC Stenogr..



RRB NTPC



SSC GD



RBI GRADE B



RBI Assistant



DSSSB

RRB NTPC 2016 (CBT 1) Previous Year Paper (7 April 2016) Shift 3

Total Time: 1 Hour : 30 Minute

Total Marks: 100

Instructions

Sl No.	Section Name	No. of Question	Maximum Marks	Negative Marks	Positive Marks
1	Test	100	100	0.33	1

- 1.) A total of 90 minutes is allotted for the examination.
- 2.) The server will set your clock for you. In the top right corner of your screen, a countdown timer will display the remaining time for you to complete the exam. Once the timer reaches zero, the examination will end automatically. The paper need not be submitted when your timer reaches zero.
- 3.) There will, however, be sectional timing for this exam. You will have to complete each section within the specified time limit. Before moving on to the next section, you must complete the current one within the time limits.

Your Personal Exams Guide

Test

1. What is a branch of science that deals with life or the possibilities of life beyond the earth? (+1, -0.33)

- A. Entomology
- B. Exobiology
- C. Mycology
- D. Paleontology

- a. B
- b. A
- c. D
- d. C

2. What do you understand by carbon credit? (+1, -0.33)

- A. It is a credit program initiated by the IPCC to provide loans for technology upgradation.
- B. It is a credit awarded to the institution based on the carbon emissions allowed and the carbon emissions actually emitted. It can also be traded.
- C. It is a program initiated by the IMF to fund environmentally friendly technology.
- D. It is a program to fund environmentally friendly cooking options.

- a. A
- b. C

c. D

d. B

3. Prachi takes Rs. 550 at 5% of simple annual interest. After 4 years, how much money will she have to pay? (+1, -0.33)

A. 101

B. 606

C. 660

D. 110

a. D

b. C

c. A

d. B

prepp

Your Personal Exams Guide

4. There is a difference of 3 rupees in the selling price when an item is sold at a profit of 4% and 10%, then the ratio of the selling price of both is: (+1, -0.33)

A. 52 : 55

B. 51 : 55

C. 37 : 35

D. 55 : 53

a. B

b. D

c. A

d. C

5. Direction: Read the given information carefully and answer the following questions. (+1, -0.33)

In the following figure, the small quadrilateral represents those who know French, the triangle represents those who know Chinese, the larger quadrant represents those who know Turkish, and the circle represents those who know Odia. Statistics from 12 to 1 are given in various fields.

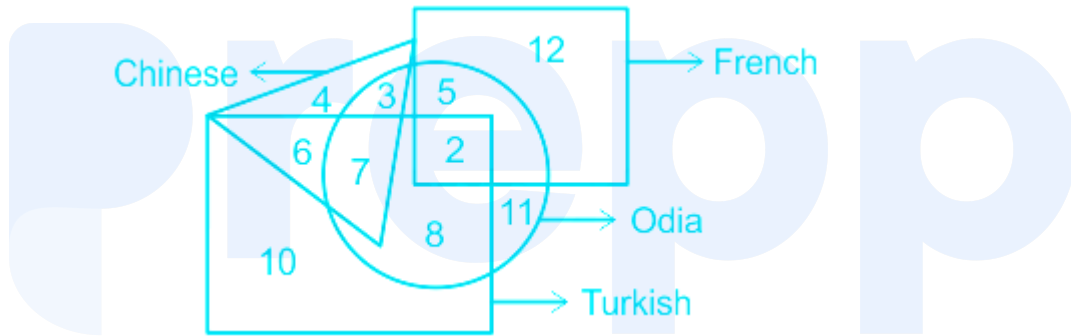

How many people can speak in both French and Odia?

A. 5

B. 8

C. 7

D. 18

a. D

b. C

c. B

d. A

6. Direction: Read the given information carefully and answer the following questions. (+1, -0.33)

In the following figure, the small quadrilateral represents those who know French, the triangle represents those who know Chinese, the larger quadrilateral represents those who know Turkish, and the circle represents those who know Odia. Statistics from 12 to 1 are given in various fields.

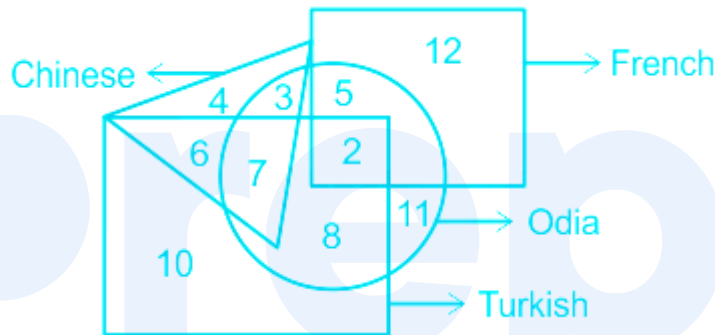

How many people can speak in french only?

- A. 9
 - B. 12
 - C. 7
 - D. 19
- a. C
 - b. D
 - c. A
 - d. B

Your Personal Exams Guide

7. Direction: Read the given information carefully and answer the following questions. (+1, -0.33)

In the following figure, the small quadrilateral represents those who know French, the triangle represents those who know Chinese, the larger quadrilateral represents those who know Turkish, and the circle represents those who know Odia. Statistics from 12 to 1 are given in various fields.

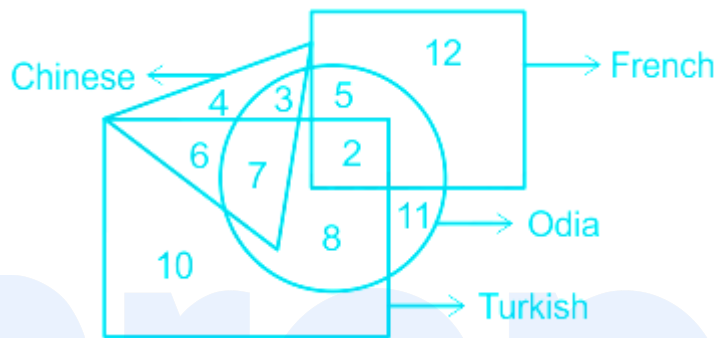

How many people can speak both Chinese and Turkish?

- A. 10
 - B. 11
 - C. 13
 - D. 12
- a. D
b. C
c. B
d. A
-
8. Rani (Girl) said pointing to a man in a photo. His mother's only daughter is my mother. How is Rani related to the man? (+1, -0.33)

- A. Wife
- B. Sister
- C. Niece
- D. Nephew

- a. C
- b. A
- c. D
- d. B

9. Calculate $26064 \div 543 \div 8$. (+1, -0.33)

- A. 60
- B. 384
- C. 6
- D. 348

- a. B
- b. C
- c. A
- d. D

10. Kumbh Mela takes place in which of these cities of Madhya Pradesh - (+1, -0.33)

- A. Gwalior

B. Bhopal

C. Ujjain

D. Indore

a. D

b. B

c. A

d. C

11. Pointing to the man receiving the award, Sunny said, "He is the brother of my uncle's daughter." How man is related to Sunny? (+1, -0.33)

A. Cousin

B. Brother-in-Law

C. Nephew

D. Uncle

a. B

b. A

c. C

d. D

12. Read the statements and select one conclusion from the given alternatives. (+1, -0.33)

Statement:

At the book fair, one author's books are displayed to the public

The prices of books are too high for a common man

Conclusions:

I. Layman only buys books from the exhibition

II. Expensive painting is usually displayed at the art gallery.

A. Only I follow

B. Only II follows

C. Both I and II follow

D. Neither I nor II follow

a. C

b. B

c. D

d. A

prepp

Your Personal Exams Guide

13. In a certain code language PARIS is coded as QBSJT, How will LONDON be coded in that code language? (+1, -0.33)

A. EPOMPO

B. POMPOE

C. MPOEOP

D. MPOEPO

a. C

- b. A
- c. B
- d. D

14. Find the standard deviation if the variance of a data set is 361. (+1, -0.33)

- A. ± 19
- B. 19
- C. 361
- D. 180.5

- a. C
- b. A
- c. B
- d. D



15. 15 men can make a toy in 20 days. How much time will 8 men take to make it? (+1, -0.33)

- A. 37
- B. 37.5
- C. 37.4
- D. 37.6

- a. A

- b. B
- c. C
- d. D

16. Who was selected for the Hridaynath Mangeshkar Award 2015 for his/her contribution to Indian music - (+1, -0.33)

- A. Asha Bhosle
- B. Annu Malik
- C. Bappi Laheri
- D. AR Rahman

- a. A
- b. B
- c. D
- d. C

prepp
Your Personal Exams Guide

17. If $\cot x = \frac{5}{12}$, then $\sin x + \cos x = ?$ (+1, -0.33)

- A. $\frac{31}{17}$
- B. $\frac{27}{13}$
- C. $\frac{13}{17}$
- D. $\frac{17}{13}$

- a. B
- b. D
- c. C
- d. A

18. Given: If $w = -2$, $x = 3$, $y = 0$, and $z = -1/2$, then Find the value of $x\sqrt{(x+wz)}$ (+1, -0.33)

- A. ± 6
- B. -6
- C. 6
- D. 5
- a. A
- b. B
- c. C
- d. D



19. Which agency is responsible for naming the planetarium? (+1, -0.33)

- A. International Institute for Space Law
- B. International Astronomical Union
- C. International Space Coordination Group
- D. European Space Agency
- a. B

- b. A
- c. C
- d. D

20. What is the 99th amendment of the constitution about? (+1, -0.33)

- A. Starting GST in India.
- B. Establishment of National Judicial Appointments Commission.
- C. Empowering the Governor of Karnataka to take steps for the development of Hyderabad-Karnataka region.
- D. Agreement on the land border between Bangladesh and India.

- a. A
- b. D
- c. C
- d. B

Prepp
Your Personal Exams Guide

21. The game of golf began in the 15th century in the country of (+1, -0.33)

- A. England
- B. Scotland
- C. Ireland
- D. Italy

- a. A

- b. B
- c. D
- d. C

22. Complete the picture X from the given options 1, 2, 3, 4.

(+1, -0.33)

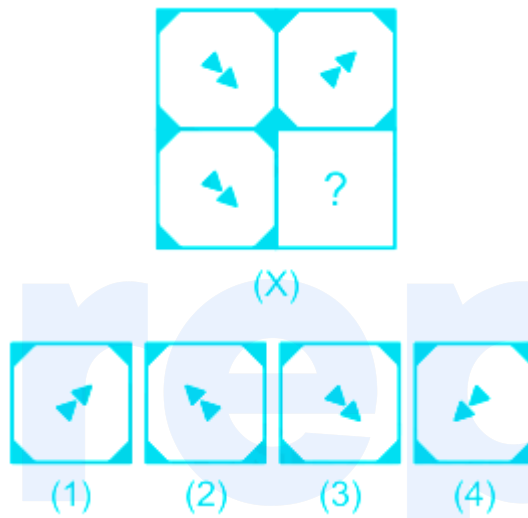

- A. 1
- B. 2
- C. 3
- D. 4
- a. A
- b. B
- c. C
- d. D

23. The World Youth and Cadet Chess Championship held in October- November 2015 was Played in _ _ _ _ _ . (+1, -0.33)

- A. Chennai
- B. Venice
- C. Porto Carras, Chalkidiki)
- D. Moscow

- a. D
- b. B
- c. C
- d. A

24. Find the value of $0.1404 \div 0.06 = ?$ (+1, -0.33)

- A. 0.234
- B. 2.34
- C. 234
- D. 23.4

- a. C
 - b. B
 - c. D
 - d. A
-

25. The order of rotational symmetry of a square is :

(+1, -0.33)

- A. 2
- B. 6
- C. 4
- D. 8
- a. C
- b. B
- c. A
- d. D

26. What is the national dress of Japan?

(+1, -0.33)

- A. Chador
- B. Kilt
- C. Sarong
- D. Kimono
- a. A
- b. B
- c. C
- d. D

27. The oral polio vaccine was developed by

(+1, -0.33)

- A. Edward Jenner
- B. Alexander Fleming
- C. Albert Sabin
- D. Jonas Salk

- a. D
- b. C
- c. A
- d. B

28. Choose the odd from the following. (+1, -0.33)

- A. Mercury
- B. Quicksilver
- C. Hydrargyrum
- D. Bromos

- a. B
- b. D
- c. C
- d. A

29. What is the main feature of 'My Stamp' launched by the Indian Postal Service for the people of Mumbai? (+1, -0.33)

- A. Order postage stamp on a mobile application
- B. Pay online for a speed post
- C. Get your personal postage stamp
- D. Postpaid stamp service

- a. C
- b. D
- c. A
- d. B

30. A greenhouse gas is a gaseous mixture capable of ----- . (+1, -0.33)

- A. Equally visible and infrared
- B. More visible radiation than infrared
- C. More infrared radiation than visible
- D. Neither visible nor infrared radiation

- a. A
- b. D
- c. C
- d. B

31. Simplify: $3x(x - 1) - 7x^2$: (+1, -0.33)

- A. $-4x^2 - 3$

B. $-10x^2 + 3x$

C. $-4x^2 + 3x$

D. $-4x^2 - 3x$

a. B

b. C

c. D

d. A

32. Answer the questions based on the information given below. (+1, -0.33)

If '+' is 'x', '-' is '+', 'x' is '÷' and '÷' is '-'

$28 \div 16 \times 2 + 3 - 1 = ?$

A. 5

B. 9

C. 4

D. 11

a. B

b. D

c. A

d. C

33. What is the principle to be followed in a cooperative society? (+1, -0.33)

- A. Multiple votes
- B. One man one vote
- C. No vote
- D. One share one vote

- a. A
- b. C
- c. B
- d. D

34. LPG in a domestic gas cylinder is stored in- (+1, -0.33)

- A. Solid State
- B. Gas State
- C. Liquid State
- D. Can be stored at any state

- a. B
- b. D
- c. A
- d. C

35. Answer the questions based on the information given below. (+1, -0.33)

If '+' is 'x', '-' is '+', 'x' is '÷' and '÷' is '-'

$$15 \times 5 \div 3 + 1 - 1 = ?$$

- A. -1
- B. -2
- C. 3
- D. 1
- a. B
- b. C
- c. A
- d. D

36. Answer the questions based on the information given below.

(+1, -0.33)

If '+' is 'x', '-' is '+', 'x' is '÷' and '÷' is '-'

$$9 - 3 + 2 \div 16 \times 2 = ?$$

- A. 7
- B. 5
- C. 9
- D. 6
- a. A
- b. C
- c. B
- d. D

prepp
Your Personal Exams Guide

37. What is the normal size of planetary paths of planets?

(+1, -0.33)

- A. Circular
- B. Parabolic
- C. Elliptical
- D. Conical

- a. A
- b. D
- c. C
- d. B

38. Three of the four pairs of words below are similar in some ways, and one pair is different. Which pair is different from the rest?

(+1, -0.33)

- A. Stallion : Colt
- B. Horse : Mare
- C. Dog : Bitch
- D. Drake : Duck

- a. D
- b. C
- c. A
- d. B

39. On which river is Hirakud Dam built?

(+1, -0.33)

- A. Cauvery
- B. Gandak
- C. Mahanadi
- D. Batarani

- a. B
- b. A
- c. D
- d. C

40. Which of the following is not one of Kepler's rules for planetary bodies?

(+1, -0.33)

- A. A planet's orbit is an ellipse with the Sun at one of the two center-points.
- B. A line segment connecting a planet and the sun makes an equal area outside during equal intervals of time.
- C. The square of the orbital period of a planet is proportional to the cube of the semi-major axis of its orbit.
- D. The orbital period depends on the mass of the planet

- a. D
- b. C
- c. B

d. A

41. Which amendment of the constitution provides 27% reservation for other backward classes as private higher education institutions in government? **(+1, -0.33)**

- A. 91st amendment
- B. 92nd Amendment
- C. 93rd amendment
- D. 94th amendment

a. C

b. D

c. B

d. A

42. Who provided the vaccine for smallpox? **(+1, -0.33)**

- A. Edward Jenner
- B. Robert Koch
- C. Pearl Kendrick
- D. Alexander Fleming

a. A

b. D

c. C

d. B

43. _____ is an endangered Indian medicinal plant species. (+1, -0.33)

A. Napendenthes

B. Podophyllum

C. Opium

D. Basil

a. A

b. C

c. D

d. B

44. Calculate: $3668 \div 524 - 9$ (+1, -0.33)

A. 2

B. -2

C. $\frac{3668}{515}$

D. $\frac{3686}{515}$

a. A

b. C

c. B

prepp

Your Personal Exams Guide

d. D

45. Find the HCF of 4432, 3324.

(+1, -0.33)

A. 277

B. 267

C. 1108

D. 1107

a. C

b. B

c. D

d. A

46. Read the statement and choose one conclusion from the given alternatives. :

(+1, -0.33)

Statement:

All countries are districts

Some villages are not districts

Conclusions:

1. All countries are villages

2. Some countries are villages

3. Some villages are not countries

4. Some countries are not villages

- A. None follows
 - B. Only 2 and 4 follow
 - C. Only 2 and 3 follow
 - D. All follows
- a. A
 - b. B
 - c. C
 - d. D

47. Find the length of the diagonal of a rectangle of length 6 cm and width 2 cm. (+1, -0.33)

- A. $2\sqrt{10}$ cm
- B. $\pm 2\sqrt{10}$ cm
- C. $4\sqrt{2}$ cm
- D. $\pm 4\sqrt{2}$ cm

- a. D
- b. A
- c. B
- d. C

48. Answer the questions based on the information given below. (+1, -0.33)

If '+' is 'x', '-' is '+', 'x' is '÷' and '÷' is '-'

$$21 \div 8 + 2 - 12 \times 3 = ?$$

A. 14

B. 9

C. 13.5

D. 11

a. A

b. C

c. B

d. D

49. The ratio of the two numbers is 2 : 9 and the HCF is 32, then their LCM is: **(+1, -0.33)**

A. 576

B. 64

C. 288

D. 567

a. A

b. B

c. C

d. D

50. If a shopkeeper cheats up to 12% in buying and selling fruits, using less weight, then his total profit percentage is: (+1, -0.33)

- A. 25.25
- B. 27.27
- C. 25.75
- D. 25.5

- a. B
- b. A
- c. C
- d. D

51. Poorvi (Boy) introduces Arjuna, as his mother's brother's son. How is Arjuna related to Poorvi? (+1, -0.33)

- A. Son
- B. Cousin
- C. Grandson
- D. Uncle

- a. B
- b. D
- c. C
- d. A

52. Solve. $5x - 4 = 3 - x$

(+1, -0.33)

- A. $\frac{1}{6}$
 - B. $1\frac{1}{6}$
 - C. 1.16
 - D. 1.17
- a. A
 - b. B
 - c. D
 - d. C

53. In which of the following places did the Portuguese build their first fort in India?

(+1, -0.33)

- A. Cochin
 - B. Goa
 - C. Karaikal
 - D. Bangalore
- a. C
 - b. B
 - c. D
 - d. A

54. Which country is the current (FIFA U-17) World Cup champion?

(+1, -0.33)

- A. Nigeria
- B. Switzerland
- C. Mexico
- D. Argentina

- a. B
- b. C
- c. D
- d. A

55. Read the statement and choose one conclusion from the given alternatives:

(+1, -0.33)

Statements:

1. Satyavan is not Harish's father
2. Harish is the son of Suraj
3. Suraj has three sons

conclusions :

- A. Satyavan is the son of Suraj
- B. Harish is the brother of Satyavan
- C. Suraj is Harish's father
- D . Satyavan has no child

- a. C
 - b. B
 - c. A
 - d. D
-

56. Calculate: 21212×9999

(+1, -0.33)

- A. 212088788
- B. 212078788
- C. 212089788
- D. 212098788

- a. A
- b. C
- c. B
- d. D

prepp
Your Personal Exams Guide

57. The spontaneous net moonset in a region of high density through a semi-permeable membrane of solvent molecules that equate the density of dissolved matter in both directions is called?

(+1, -0.33)

- A. Active movement
- B. passive movement
- C. Reverse Osmosis
- D. Osmosis

- a. C
- b. B
- c. D
- d. A

58. Complete the figure X from the given 1, 2, 3, 4 options.

(+1, -0.33)

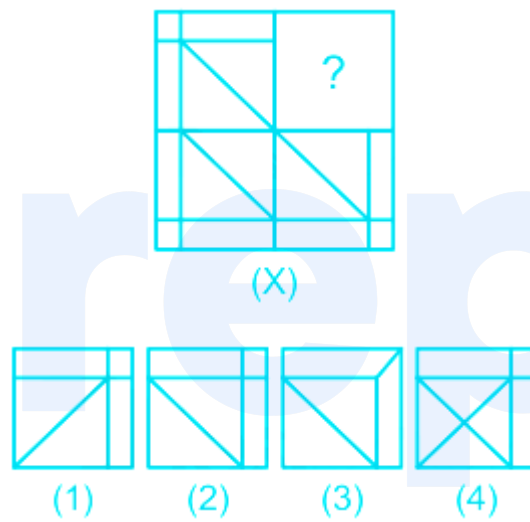

- A. 1
- B. 2
- C. 3
- D. 4
- a. B
- b. A
- c. D
- d. C

prepp
Your Personal Exams Guide

59. If 95 rupees is divided in the ratio of 2 : 3 : 6 : 8, then the rupees will be in many related proportions: (+1, -0.33)

- A. 10, 15, 31 & 39
- B. 10, 15, 29 & 41
- C. 10, 15, 30 & 40
- D. 10, 16, 29 & 40

- a. B
- b. D
- c. A
- d. C

60. Queen Elizabeth II has recently become the longest-reigning monarch in Britain, having passed the record set by- (+1, -0.33)

- A. Queen Elizabeth First
- B. Queen Anne
- C. King George
- D. Queen Victoria

- a. B
- b. D
- c. A
- d. C

61. Ajanta caves in Aurangabad district of Maharashtra, in which about 30 rock-cut Buddhist caves were built, how ancient was that? (+1, -0.33)

- A. 8th century BC
- B. 2nd century BC
- C. 6th century BC
- D. 4th century BC

- a. B
- b. C
- c. D
- d. A

62. Namrata takes 4 hrs 15 mins to walk from one place to the same place (by walking and coming back from the vehicle). She can cover both ways in 5 hours and 30 minutes by walking. The time it takes for her to come back from both the paths from the vehicle is: (+1, -0.33)

- A. 3 hrs
- B. 3 hrs 35 mins
- C. 3 hrs 45 mins
- D. 3 hrs 15 mins

- a. A
- b. B
- c. C

d. D

63. Who among the following defeated Mohammad Ghori of the Ghori dynasty at Kayadara village near Mount Abu? (+1, -0.33)

- A. Bhimdev Solanki I
- B. Kulothunga Chola I
- C. Bhimdev Solanki II
- D. Kulothunga Chola II

a. D

b. A

c. C

d. B

64. The product of two numbers is 1568 and LCM 56, then their HCF is: (+1, -0.33)

- A. 68
- B. 58
- C. 38
- D. 28

a. A

b. D

c. B

d. C

65. Which of the following parties was founded by Netaji Subhash Chandra Bose? (+1, -0.33)

- A. Indian National Congress
- B. All India Forward Block
- C. Socialist Party of India
- D. Social Reformist Party of India

a. D

b. C

c. A

d. B

66. The following information is related to the sample of the size of 60, $\sum x^2 = 18000$, $\sum x = 960$, So variance is (+1, -0.33)

- A. 55
- B. 44
- C. 22
- D. 16

a. D

b. B

c. A

d. C

67. Three of the four pairs of words below are alike in some way and each pair is different. Which pair is different from the other pairs? (+1, -0.33)

A. Ornithology: Birds

B. Mycology: Fungi

C. Biology: Botany

D. Phycology: Algae

a. B

b. A

c. D

d. C

68. Which of the following is used by dentists as a substitute for anesthetics? (+1, -0.33)

A. Oxygen

B. Nitrogen

C. Nitrous Oxide

D. Chlorine

a. B

b. C

c. A

d. D

69. If $\sin A = \frac{15}{17}$ and $\sin B = \frac{7}{25}$, then $\sin (A - B) = ?$ (+1, -0.33)

A. $\frac{304}{425}$

B. $\frac{416}{425}$

C. $\frac{297}{425}$

D. $\frac{87}{425}$

a. A

b. C

c. D

d. B

70. In New Zealand, what colors are used for tsunami warning signs? (+1, -0.33)

A. White and Blue

B. White and Green

C. Red and Green

D. Yellow and Green

a. D

b. A

c. C

d. B

71. Rajneesh covers equal distances at speeds of 6 km/h, 4 km/h and 8 km/h respectively and takes a total time of 32.5 minutes. Find the total distance in km. (+1, -0.33)

A. 4

B. 2

C. 1

D. 3

a. D

b. B

c. C

d. A

72. How many bits are equal to one byte? (+1, -0.33)

A. 4

B. 8

C. 12

D. 32

a. D

b. C

c. A

d. B

73. Lohit, as an airman, is twice as capable as Aayush and together they finish a job in 17 days. In how many days does Aayush alone finish the same work? (+1, -0.33)

A. 34

B. 51

C. 68

D. 40

a. D

b. B

c. A

d. C

74. Which of the following cities falls on the line of the equator? (+1, -0.33)

A. Pontianak

B. Cairo

C. Port Blair

D. Addis Ababa

a. D

b. A

c. C

d. B

75. Read the statement and choose one conclusion from the given alternatives.: (+1, -0.33)

Statements:

1. Nobody else but only the poor can spend on rickshaws
2. Some people travelling by rickshaw become ill
3. Some of those who become ill require treatment.

Conclusions:

- A. All poor people travel by rickshaw.
- B. People who travel by rickshaw become ill.
- C. All poor people become ill.
- D. All those who travel by rickshaw are poor.

a. B

b. A

c. C

d. D

76. Antiseptic properties in soap are found due to one of the following mixtures- (+1, -0.33)

- A. Bithional
- B. Sodium lauryl sulfate

C. Rosin

D. Sodium dodecyl benzenesulfonate

a. B

b. D

c. C

d. A

77. In a certain code language, if AKASH is coded as 29208 and BRIJESH is coded as 1536708, then how will SHABIR be coded? (+1, -0.33)

A. 549046

B. 531280

C. 802531

D. 082135

a. A

b. D

c. C

d. B

78. Amit sells a bus at a loss of 15% for Rs. 23,800. At what price should he sell the bus to get 15% profit? (+1, -0.33)

A. 32,100

B. 33,300

C. 32,300

D. 32,200

a. D

b. B

c. A

d. C

79. **Direction:** 'Five students – Anil, Baruna, Chitra, Dave, and Elsa – represent their schools in five different sports such as cricket, football, basketball, badminton and kabaddi. (+1, -0.33)

Anil plays football. Baruna and Dave do not play badminton or cricket.

Chitra does not play kabaddi. Elsa does not play cricket, basketball or kabaddi.

Who plays cricket?

A. Anil

B. Baruna

C. Chitra

D. Dev

a. D

b. C

c. B

d. A

80. **Direction:** 'Five students – Anil, Baruna, Chitra, Dave, and Elsa – represent their schools in five different sports such as cricket, football, basketball, badminton and kabaddi. (+1, -0.33)

Anil plays football. Baruna and Dave do not play badminton or cricket.

Chitra does not play kabaddi. Elsa does not play cricket, basketball or kabaddi.

What sports does Baruna play?

- A. Cricket
 - B. Badminton
 - C. Basketball
 - D. Cannot be determined
- a. C
- b. D
- c. B
- d. A

81. **Direction:** 'Five students – Anil, Baruna, Chitra, Dave, and Elsa – represent their schools in five different sports such as cricket, football, basketball, badminton and kabaddi. (+1, -0.33)

Anil plays football. Baruna and Dave do not play badminton or cricket.

Chitra does not play kabaddi. Elsa does not play cricket, basketball or kabaddi.

Who plays badminton?

A. Baruna

B. Chitra

C. Elsa

D. Anil

a. B

b. D

c. A

d. C

82. If a person is suffering from rickets, the person lacks _____.- (+1, -0.33)

A. Vitamin K

B. Vitamin D

C. Vitamin A

D. Vitamin B

a. C

b. A

c. D

d. B

83. _____ is a device that modulates signals to encode digital information and demodulates the signal to decode the transmitted information. (+1, -0.33)

- A. Printer)
- B. CPU
- C. Keyboard
- D. Modem

- a. B
- b. C
- c. A
- d. D

84. Days of Grace is a biography of which tennis legend? (+1, -0.33)

- A. Chris Evert
- B. John McEnroe
- C. Steffi Graf
- D. Arthur Ashe

- a. C
- b. A
- c. D
- d. B

85. Whose ascending order is correct from the given numbers. (+1, -0.33)

- A. $\frac{5}{6}, \frac{11}{12}, \frac{8}{9}$

B. $\frac{8}{9}, \frac{5}{6}, \frac{11}{12}$

C. $\frac{5}{6}, \frac{8}{9}, \frac{11}{12}$

D. $\frac{11}{12}, \frac{8}{9}, \frac{5}{6}$

a. D

b. B

c. C

d. A

86. Read the statement and choose one conclusion from the given alternatives:

(+1, -0.33)

Statement:

All bottles are pencils

No pencil is school

Conclusions:

1. Some bottles are not school
 2. Some schools are not bottles
 3. Some pencils are school
- A. Only I follow
- B. None follow
- C. Either I or II and III follow
- D. Only I and II follow

- a. C
 - b. A
 - c. B
 - d. D
-

87. Which one of the following statements is not correct? (+1, -0.33)

- A. An estuary consists of the sea at one end and a river at the other.
- B. Water is saltier than a river in a creek
- C. A creek is a producer of a wide variety of biodiversity.
- D. The bay can also be completely surrounded

- a. B
- b. D
- c. C
- d. A

88. Light-emitting diode (LED) is used in electronic devices such as television (+1, -0.33)

leaves _____.

- A. Ultraviolet rays
- B. X-ray
- C. Radio Waves
- D. Visible Light

- a. B
 - b. A
 - c. C
 - d. D
-

89. If in a certain code language, TIGER is coded as UJHFS, how will MOUSE be coded in that code language? (+1, -0.33)

- A. NPVFT
- B. NVPTF
- C. NPVTF
- D. NTFVP

- a. A
- b. C
- c. B
- d. D



90. In a polygon, each external angle is 120° , so the number of sides is (+1, -0.33)

- A. 6
- B. 4
- C. 3
- D. 5

- a. A
 - b. C
 - c. B
 - d. d
-

91. In a certain code language, if SHILPA is coded as 841352 and SUNIL is coded as 86913 then how will ANIL be coded? (+1, -0.33)

- A. 1392
- B. 3129
- C. 2913
- D. 1932

- a. B
- b. A
- c. C
- d. D



92. In which country is Africa's highest mountain, Kilimanjaro located? (+1, -0.33)

- A. Tanzania
- B. Nigeria
- C. Ghana
- D. South Africa

- a. B
- b. A
- c. C
- d. D

93. **Direction:** Study the following table and answer the questions:

(+1, -0.33)

The table below gives its figures - the number of candidates who have applied for a competitive examination from different states over the years and the number of candidates passed from it.

Prepp

Your Personal Exams Guide

State	Year									
	1997		1998		1999		2000		2001	
	App.	Qual.	App.	Qual.	App.	Qual.	App.	Qual.	App.	Qual.
M	5200	720	8500	980	7400	850	6800	775	9500	1125
N	7500	840	9200	1050	8450	920	9200	980	8800	1020
P	6400	780	8800	1020	7800	890	8750	1010	9750	1250
Q	8100	950	9500	1240	8700	980	9700	1200	8950	995
R	7800	870	7600	940	9800	1350	7600	945	7990	885

The average number of candidates who appeared from State M during the given years is

- A. 7700
 - B. 7760
 - C. 7480
 - D. 7920
- a. A
- b. B

c. C

d. D

94. **Direction:** Study the following table and answer the questions:

(+1,
-0.33)

The table below gives its figures - the number of candidates who have applied for a competitive examination from different states over the years and the number of candidates passed from it.

State	Year									
	1997		1998		1999		2000		2001	
	App.	Qual.	App.	Qual.	App.	Qual.	App.	Qual.	App.	Qual.
M	5200	720	8500	980	7400	850	6800	775	9500	1125
N	7500	840	9200	1050	8450	920	9200	980	8800	1020
P	6400	780	8800	1020	7800	890	8750	1010	9750	1250
Q	8100	950	9500	1240	8700	980	9700	1200	8950	995
R	7800	870	7600	940	9800	1350	7600	945	7990	885

In which of the following years the maximum percentage of qualified candidates out of the number of candidates present of state R?

- A. 1997
 - B. 1998
 - C. 2000
 - D. 1999
-
- a. B
 - b. A
 - c. D
 - d. C

95. **Direction:** Study the following table and answer the questions:

(+1,
-0.33)

The table below gives its figures - the number of candidates who have applied for a competitive examination from different states over the years and the number of candidates passed from it.

Your Personal Exams Guide

State	Year									
	1997		1998		1999		2000		2001	
	App.	Qual.	App.	Qual.	App.	Qual.	App.	Qual.	App.	Qual.
M	5200	720	8500	980	7400	850	6800	775	9500	1125
N	7500	840	9200	1050	8450	920	9200	980	8800	1020
P	6400	780	8800	1020	7800	890	8750	1010	9750	1250
Q	8100	950	9500	1240	8700	980	9700	1200	8950	995
R	7800	870	7600	940	9800	1350	7600	945	7990	885

The total number of applications of candidates from all states in the year 2000 is approximately what percent of the total number of applications of candidates from all states in the year 2001?

- A. 90%
- B. 94%
- C. 93.4%
- D. 91%

a. A

b. B

c. C

d. D

96. $1, \frac{1}{2}, \frac{1}{2}, \frac{3}{4}, \frac{1}{4}, 2, \frac{1}{2}, \frac{1}{4}, \frac{3}{4}$ mode of data is; (+1, -0.33)

A. $\frac{1}{4}$

B. $\frac{1}{2}$

C. $\frac{3}{4}$

D. 1

a. A

b. B

c. D

d. C

prepp

Your Personal Exams Guide

97. Prakash invests in an FD. What will be the maturity amount with an annual recurring interest of 20% for 6 months at Rs. 13,000, interest compounded quarterly? (+1, -0.33)

A. 14332.25

B. 14332.5

C. 14332.75

D. 14332

- a. D
 - b. B
 - c. A
 - d. C
-

98. Read the statement and choose one conclusion from the given alternatives.: (+1, -0.33)

Statement:

All rats are books

All rats are mice

Conclusions:

- 1. Some books are mice
 - 2. All books are mice
 - 3. Some mice are not rats
- A. Only 1 follow
 - B. Only 1 and 3 follow
 - C. Only 1 and 2 or 3 follows
 - D. Both 2 and 3 follow

- a. B
- b. A
- c. C

d. D

99. Which of the following freedom fighters wrote the epic 'Kamala' on the prison walls? (+1, -0.33)

A. Madan Mohan Malviya

B. VD Savarkar

C. Sharatchandra

D. Batukeshwar Dutt

a. A

b. C

c. B

d. D

100. $(4)^{\frac{-3}{2}} = ?$ (+1, -0.33)

A. $1/4$

B. 8

C. $1/8$

D. 4

a. B

b. A

c. C

d. D

prepp

Your Personal Exams Guide

Answers

1. Answer: a

Explanation:

The correct answer is B.

- The branch of biology related to the classification of organisms is called 'Taxonomy'.
- Under this, **plants and animals** of different species are studied.
- **Entomology** - Under this branch, insects are studied.
- **Mycology** - Under this branch, the fungus is studied.
- **Paleontology** - Under this branch, the fossils of animals and plants are studied.
- **Arachnology** - Under this branch, spiders are studied.
- **Primatology** - Under this, the behavior of the human-like species is studied.

2. Answer: d

Explanation:

The correct answer is It is a credit awarded to the institution based on the carbon emissions allowed and the carbon emissions actually emitted. It can also be traded.

- "Carbon credit" plans to control emissions in the international industry.
- The 'United Nations Framework Work Connection on Climate Change' for 'Carbon Emissions' has set the criteria and criteria, **UNFCCC is part of the United Nations**.
- By contacting the UNFCCC, you can control the carbon emission level determined according to its criteria.
- If you are emitting carbon below that specified level then the difference between the set level and the carbon you emit will be called your "carbon credit".
- This process is also going to provide benefits along with "environmental protection".

3. Answer: b

Explanation:

Given:

Principal, P = Rs. 550

Rate of interest = 5%

Time = 4 years

Formula used:

$$S.I. = P \times R\% \times T$$

$$\text{Amount} = P + S.I.$$

Calculation:

$$S.I. = P \times R\% \times T$$

$$\Rightarrow S.I. = 550 \times 5/100 \times 4$$

$$\Rightarrow S.I. = \text{Rs. } 110$$

$$\text{Amount} = P + S.I.$$

$$\Rightarrow \text{Amount} = 550 + 110$$

$$\Rightarrow \text{Amount} = \text{Rs. } 660$$

\therefore She will have to pay Rs. 660.

4. Answer: c

Explanation:

Given:

Profit% = 4%

Increased profit% = 10%

Difference = Rs. 3

Concept used:

SP = (100 + Profit%) of CP

Calculation:

Let the CP of an item be Rs. x .

Required difference = SP at 10% – SP at 4%

$$\Rightarrow 3 = (100 + 10)\% \text{ of } x - (100 + 4)\% \text{ of } x$$

$$\Rightarrow 3 = 110/100 \times x - 104/100 \times x$$

$$\Rightarrow 3 = x(110 - 104)/100$$

$$\Rightarrow 300 = 6x$$

$$\Rightarrow x = \text{Rs. } 50$$

SP at 4% = (100 + 4)% of x

$$\Rightarrow \text{SP at 4\%} = 104/100 \times 50$$

SP at 4% = Rs. 52

SP at 10% = (100 + 10)% of x

$$\Rightarrow \text{SP at 10\%} = 110/100 \times 50$$

$$\Rightarrow \text{SP at 10\%} = \text{Rs. } 55$$

Required ratio = SP at 4% : SP at 10%

⇒ Required ratio = 52 : 55

∴ The ratio of the selling price of both is 52 : 55.

5. Answer: b

Explanation:

Given,

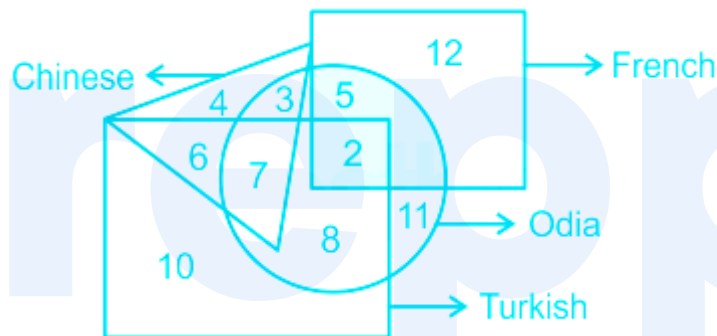

The small quadrilateral represents those who know French, the triangle represents those who know Chinese, the larger quadrant represents those who know Turkish, and the circle represents those who know Odia.

From the above information, we know that there are 7 people who know both French and Odia.

Hence, the correct answer is C. 7.

6. Answer: d

Explanation:

Given,

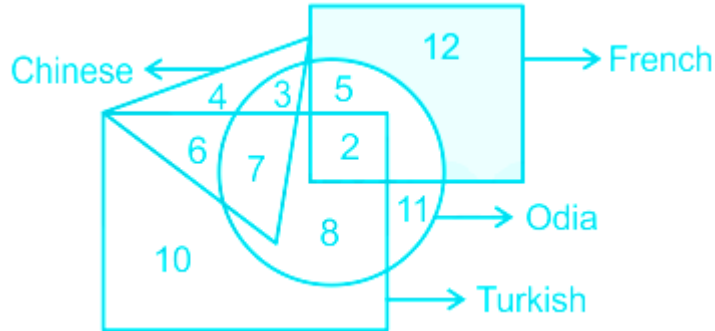

The small quadrilateral represents those who know French,
 the triangle represents those who know Chinese,
 the larger quadrant represents those who know Turkish,
 and the circle represents those who know Odia.

From the above information, we know that there are 12 people who know only French.

Hence, the correct answer is B. 12.

Your Personal Exams Guide

7. Answer: b

Explanation:

Given,

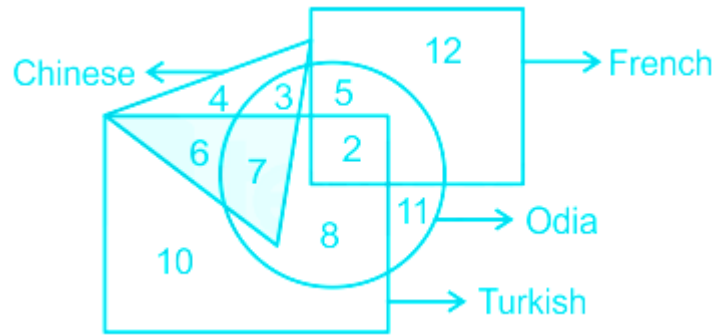

The small quadrilateral represents those who know French,
 the triangle represents those who know Chinese,
 the larger quadrant represents those who know Turkish,
 and the circle represents those who know Odia.

From the above information, we know that there are 13 people who know both Chinese and Turkish.

Hence, the correct answer is C. 13.

8. Answer: a

Explanation:

Symbol in Diagram	Meaning
○	Female
□	Male
══	Married Couple
—	Siblings
	Difference of A Generation

Given,

Rani said pointing to a man in a photo. His mother's only daughter is my mother.

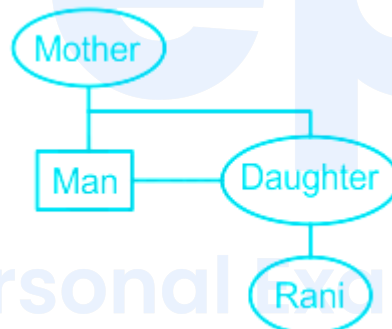

Here we see Rani is the niece of the man in the photo.

Hence, the correct answer is the niece.

9. Answer: b

Explanation:

Given:

$$26064 / 543 / 8 = ?$$

Concept used:

B	Brackets in order (), {}, []	ब्रैकेट (), {}, [] क्रम में
O	of	का
D	Division (÷)	विभाजन (÷)
M	Multiplication (×)	गुणा (×)
A	Addition (+)	जोड़ (+)
S	Subtraction (-)	घटाव (-)

Calculation:

$$26064 / 543 / 8$$

$$\Rightarrow 26064 / (543 \times 8)$$

$$\Rightarrow 26064 / 4344$$

$$\Rightarrow 6$$

∴ The value is 6.

10. Answer: d

Explanation:





The correct answer is C.

- Kumbh festival is an **important festival of Hinduism** which is held in 4 holy places of India, **Prayag, Haridwar, Ujjain and Nashik**.
- At each of these places, "**Kumbh**" is organized every twelfth year.

- There is also an 'Ardh Kumbh' in Prayag in a **six-year** gap between the two Kumbh festivals.
- Ujjain is a **holy city** situated on the banks of the **Kshipra River** in Madhya Pradesh.
- Indore is the largest city of Madhya Pradesh in terms of population.
- Bhopal is the capital of Madhya Pradesh.

11. Answer: b

Explanation:

Symbol in Diagram	Meaning
	Female
	Male
	Married Couple
	Siblings
	Difference of A Generation

Given,

Pointing to the man receiving the award, Sunny said, "He is the brother of my uncle's daughter."

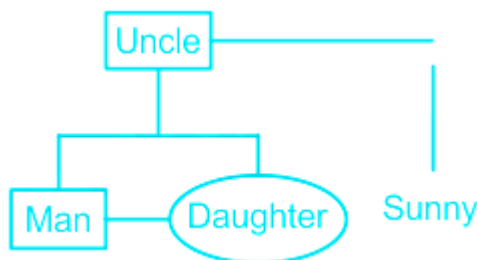

Here we see the man is Sunny's cousin.

Hence, the correct answer is A. Cousin.

12. Answer: c

Explanation:

Given,

Statement:

At the book fair, one author's books are displayed to the public

The prices of books are too high for a common man

Conclusion:

I. Layman only buys books from the exhibition → False (The first conclusion does not follow as a layman can buy books from anywhere)

II. Expensive painting is usually displayed at the art gallery → False (The second conclusion also does not follow as we do not have anything related to painting in the statement)

Here, we see neither conclusion I nor II follow.

Hence, the correct answer is D. Neither I nor II follow.

13. Answer: d

Explanation:

We know,

Given,

PARIS is coded as QBSJT.

The pattern followed here is,



Similarly

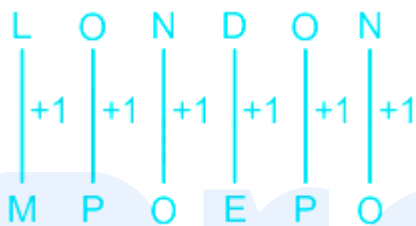

Hence, the correct answer is D. MPOEPO.

14. Answer: c

Explanation:

Given:

Variance = 361

Concept used:

The positive square root of the variance is called Standard deviation

S.D = $\sqrt{\text{Variance}}$

Calculation:

S.D = $\sqrt{\text{Variance}}$

$$\Rightarrow S.D = \sqrt{361}$$

$$\Rightarrow S.D = 19$$

\therefore The standard deviation of the data is 19.

15. Answer: b

Explanation:

Given:

$$M_1 = 15, D_1 = 20 \text{ days}$$

$$M_2 = 8,$$

Concept used:

$$M_1 \times D_1 = M_2 \times D_2$$

Calculation:

Let the 8 men will take time x days.

$$M_1 \times D_1 = M_2 \times D_2$$

$$\Rightarrow 15 \times 20 = 8 \times x$$

$$\Rightarrow 300 = 8 \times x$$

$$\Rightarrow x = 37.5$$

\therefore 8 men will take 37.5 days.

16. Answer: c

Explanation:

The correct answer is D.

- 'AR Rahman' has been conferred with the prestigious 2015 Hridaynath Mangeshkar Award in Mumbai.
- Hridaynath Mangeshkar is the son of renowned musician Deenanath Mangeshkar.
- Dinanath Mangeshkar was a famous Marathi theatre actor, music composer, and Hindustani classical musician and singer.
- This award was **established in 2011** by Hridayesh Art, a Mumbai- based socio-cultural organization.
- **The first Hridaynath Mangeshkar award** was conferred to **Lata Mangeshkar in 2011**.

17. Answer: b

Explanation:

Given:

$$\text{Cot}x = 5/12$$

Formula used:

Using basic trigonometric functions.

$$1) \text{Cot}x = B/P$$

$$2) \text{Sin}x = P/H$$

$$3) \text{Cos}x = B/H$$

Where B is base, P is perpendicular and H is the hypotenuse

Calculation:

$$\cot x = 5/12 = B/P$$

$$H^2 = B^2 + P^2$$

$$\Rightarrow H^2 = 5^2 + 12^2 = 25 + 144$$

$$\Rightarrow H^2 = 169$$

$$\Rightarrow H = 13$$

$$\sin x + \cos x = P/H + B/H = 12/13 + 5/13$$

$\therefore \sin x + \cos x$ is $17/13$

18. Answer: c

Explanation:

Given:

$$w = -2, x = 3, y = 0, \text{ and } z = -1/2$$

Calculation:

$$x\sqrt{(x+wz)} = 3\sqrt{(3 + (-2) \times (-1/2))}$$

$$\Rightarrow x\sqrt{(x+wz)} = 3\sqrt{4}$$

$$\text{As, } \sqrt{4} = 2$$

$$\therefore x\sqrt{(x+wz)} = 6$$

19. Answer: a

Explanation:

The correct answer is B.

- 'International Astronomical Union' is an organization of astronomers, which was established in the year **1919**.
- Whenever a new object is found in the universe, only the names given by the 'astronomical union' are recognized internationally.
- The 'International Astronomical Union aims to promote 'astronomical science'.
- Its central secretariat is in "Paris" .
- ★ Additional Information
 - The 'European Space Agency' is a group of 20 member countries that conduct space-related activities.
 - Its headquarters are located in 'Paris'.
 - It was established in the year 1975.

20. Answer: d

Explanation:

The correct answer is D.

- Notification of the '**National Judicial Appointments Commission**' and Constitution Amendment Act (**99th Amendment Act**) was issued on **13 April 2015** by the Department of Justice in the Union Law Ministry.
- Its objective is to change the existing system of appointment of judges in the Supreme Court and 24 High Courts of the country.
- The members of the **National Judicial Appointments Commission** will consist of two senior judges of the Supreme Court, Union Law and Justice Minister, two eminent persons nominated by the Committee of the Prime Minister of India.
- **GST was implemented in India on 1 July 2017** and the **101 Constitution Amendment** relates to GST.
- The Agreement on **Land Boundary between Bangladesh and India** is related to the **100 Constitution Amendment**.

21. Answer: b

Explanation:

The correct answer is B.

- 'Royal Calcutta', established in 1829, is the second oldest golf course in the world after St Andrews in Scotland.
- The golf game was introduced in Europe around the 15th century.
- The golf field is wide and full of green-grass. This ground is called 'Golf Course'.
- The capital of England is London, and it is the most populous city here.
- London is situated on the banks of the "Thames" river.
- The capital of Italy is "Rome" and Italy is situated on the banks of the "Tiber" River.

22. Answer: a

Explanation:

Given,



(X)

Here we see the top and bottom images are same in the left side similarly right-side images will follow the same pattern.

∴

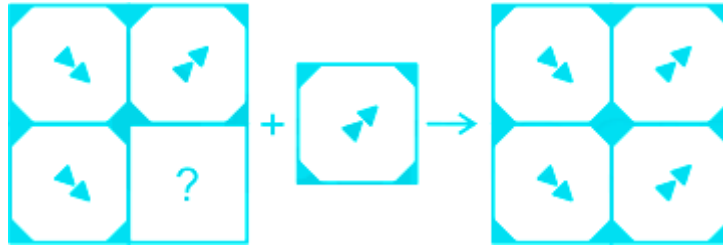

Hence, the correct answer is A. 1.

23. Answer: c

Explanation:

The correct answer is C.

- The top institution of international chess competition is "**Federation Internationale des Echecs**" (FIDE).
- The **World Youth and Cadet Chess Championship** were held between October 24 and November 6, 2015, in **Porto Caras, Mildadiki, Greece**.
- "**Masood Mossadeghpour**" of Iran won the gold medal by topping the **Open U-18 category** of the championship.
- While in the girl's **U-18 category**, "**Aman Mahalakshmi**" of **India** won the **gold medal** with the top position and Veen Varshini won the silver medal.
- **India topped the championship** by winning a total of 11 medals including **5 gold, 3 silver, and 3 bronze**.

24. Answer: b

Explanation:

Concept used:

Follow the BODMAS rule to solve this question, as per the order given below,

B	Brackets in order (), {}, []	ब्रैकेट (), {}, [] क्रम में
O	of	का
D	Division (÷)	विभाजन (÷)
M	Multiplication (×)	गुणा (×)
A	Addition (+)	जोड़ (+)
S	Subtraction (-)	घटाव (-)

Calculation:

$$0.1404 \div 0.06 = (1404/10000) \div (6/100)$$

$$\Rightarrow (1404/10000) \times (100/6)$$

$$\Rightarrow 234/100$$

$$\therefore 2.34$$

25. Answer: a

Explanation:

Calculation:

If we rotate a square ABCD, we'll get the following shapes:

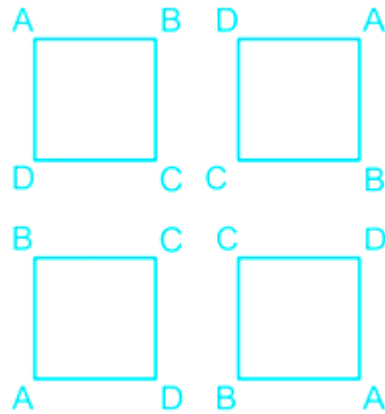

After the fourth rotation, it will be the same as the first figure

∴ Rotational symmetry is 4

26. Answer: d

Explanation:

The correct answer is D.

- The national dress of any country sustains the cultural traditions of that country.
- Different countries have their own different clothes -

Country	National Dress
Japan	Kimono
Nepal	Daura Surual
China	Hanfu
Bhutan	Gho (Men), Kira (Woman)

27. Answer: b

Explanation:

The correct answer is C.

- The first polio vaccine was developed by 'Jonas Salk' and first tested in 1952.
- "Albert Bruce Sabin" was a Polish American medical researcher known for developing the "oral polio vaccine".
- "Edward Jenner" was an English doctor and inventor of the 'smallpox vaccine'.
- Jenner is called the 'father of immunology'.
- Alexander Fleming, the inventor of penicillin, was a biologist and pharmacologist of Scotland.

28. Answer: b

Explanation:

Given,

- A. Mercury
- B. Quicksilver
- C. Hydrargyrum
- D. Bromos

Here we see Mercury, Quicksilver, Hydrargyrum all are same.

Bromos is a sedative containing Bromide.

Hence, the correct answer is D. Bromos.

29. Answer: a

Explanation:

The correct answer is C.

- Under this scheme, any person can issue a postage stamp containing a photo of himself or any of his family by spending **Rs 300** .
 - The customer can use this scheme for sending posts or for **special occasions**.
 - The Indian Postal Department celebrates '**World Postal Week** ' from **9 to 14 October**.
 - **Warren Hastings** established the first post office in **Kolkata** in the year **1774**.
 - The postal system was **first introduced in India** in the year **1766** .
 - '**World Post Day** ' is celebrated on **6 October**.
-

30. Answer: b

Explanation:

The correct answer is D.

- Greenhouse gas is a **mixture of gases** that are **neither visible nor capable of infrared radiation**.
 - Greenhouse gases allow short-wavelength radiation from the Sun to come to Earth but increase the Earth's temperature by absorbing long-wavelength radiation from the Earth.
 - Naturally found greenhouse gases in the atmosphere are **carbon dioxide, methane, water vapour and nitrous oxide**.
 - The **most prominent greenhouse gas is carbon dioxide (70 %)**.
 - These greenhouse gases cause global warming problems.
 - If there was no greenhouse gas on the earth, the temperature of the earth would be very low because this gas is helpful in making the temperature of the earth.
-

31. Answer: c

Explanation:

Calculation:

$$3x(x - 1) - 7x^2$$

$$\Rightarrow 3x \times x - 3x \times 1 - 7x^2$$

$$\Rightarrow 3x^2 - 3x - 7x^2$$

$$\therefore -4x^2 - 3x$$

32. Answer: c

Explanation:

Given,

If '+' is 'x', '-' is '+', 'x' is '÷' and '÷' is '-'

$$28 \div 16 \times 2 + 3 - 1 = ?$$

$$\therefore 28 - 16 \div 2 \times 3 + 1 = 28 - 8 \times 3 + 1 = 28 - 24 + 1 = 5$$

Hence, the correct answer is A. 5.

33. Answer: c

Explanation:

The correct answer is B.

- The word 'cooperative' means 'working together'.
- This means that individuals who want to work together for the same economic purpose can form a committee. This is called a 'cooperative society'.
- No member of the cooperative works for 'personal profit'.

- All its members collect their resources and **make maximum use** of them, which they share among themselves.
- The **primary purpose** of a cooperative society is to "**serve its members**".
- A member has the right to vote "**only one vote**" irrespective of the number of shares he has.

34. Answer: d

Explanation:

The correct answer is C.

- LPG in a domestic gas cylinder is stored in a **Liquid state**.
- The full form of "L.P.G." is "**Liquid Petroleum Gas**".
- The domestic gas cylinder contains a **mixture of propane and butane** gas in 95 % and other gases in 5 %.
- **LPG is colourless and odourless**, so the sulfur compound '**methyl mercaptan**' is added to it to detect leakage.

35. Answer: d

Explanation:

Given,

If '+' is 'x', '-' is '+', 'x' is '÷' and '÷' is '-'

$$15 \times 5 \div 3 + 1 - 1 = ?$$

$$\therefore 15 \div 5 - 3 \times 1 + 1 = 3 - 3 + 1 = 1$$

Hence, the correct answer is D. 1.

36. Answer: a

Explanation:

Given,

If '+' is '×', '-' is '+', '×' is '÷' and '÷' is '-'

$$9 - 3 + 2 \div 16 \times 2 = ?$$

$$\therefore 9 + 3 \times 2 - 16 \div 2 = 9 + 6 - 8 = 7$$

Hence, the correct answer is A. 7.

37. Answer: c

Explanation:

The correct answer is C.

- The normal size of planetary 'paths of planets' are 'elliptical'.
- **Mercury** is the **nearest planet to the Sun** and the smallest planet in the Solar System.
- There is no atmosphere on the planet Mercury, its surface is made up of rocks and mountains.
- There is **no satellite of Venus** and it is the hottest planet in the solar system.
- **Uranus** was the **first planet** to be discovered with the help of the telescope.
- The planet **Uranus** was discovered by '**William Herschel**' in the year 1781 with the help of a telescope.
- **Jupiter** is the **largest planet** in the solar system. It takes 11 years and 11 months to revolve around the Sun.

38. Answer: c

Explanation:

Given,

A. Stallion : Colt

B. Horse : Mare

C. Dog : Bitch

D. Drake : Duck

Here we see all are male and females of particular species except the Stallion : Colt in which both are male.

Hence, the correct answer is A. Stallion : Colt.

39. Answer: d

Explanation:

The correct answer is Mahanadi.

★ Key Points

- **The Hirakud Dam** is located on the '**Mahanadi River**' and its construction started in **1948** , completed in **1953**.
- One of the first river valley projects in India, the Hirakud Dam is the **longest (4801 m) dam** in the world.
- It is **located about 290 km from the city of Bhubaneswar** in the Sambalpur district of Odisha.
- **Kaveri** is flowing through **Karnataka and northern Tamil Nadu**.
- It **originates from the Brahmagiri mountain** in the Western Ghats. Its length is usually **800 kilometres**.
- **Gandak River** also called the '**Narayani**' river. It is located in central Nepal and northern India.

40. Answer: a

Explanation:

The correct answer is D.

- German mathematician and astronomer "**Kepler**" gave three laws of 'planetary motion'.
- The **geocentric concept** was given by the famous astronomer ' **Claudius Toulmi**' of Egypt.
- According to which '**Earth is at the centre of the universe and the Sun and other planets revolve around it.**'
- The '**Heliocentric concept**' was propounded by '**Copernicus**'.
- According to them, '**The Sun is at the centre of the universe and other planets including the Earth revolve around it.**'

41. Answer: a

Explanation:

The correct answer is C.

- **93rd Amendment** - This amendment was done in **2006**.
 - In this, reservation of seats has been arranged for admission of citizens of scheduled castes and tribes and **other backward classes in educational institutions**.
- **91st Amendment** - By this Amendment Act **2003**, a change was made in the provisions of the Tenth Schedule.
 - It abolished a provision that would no longer be considered disqualification on the basis of party-change in case of division, provided such division includes at **least one-third of the concerned party**.
- **92nd Amendment** - Four **new languages were added** to the eighth schedule. They are **Bodo, Dogri, Maithili, and Santhali**.

- With this, the total number of constitutionally recognized **languages** increased to **22**.

42. Answer: a

Explanation:

The correct answer is A.

★ Key Points

- The smallpox vaccine was discovered by '**Edward Jenner**'.
- Small Pox is caused due to **Variola Virus**.
- This is a **viral disease** that transmits from one person to another person.
- It affects the skin and the whole body.

★ Additional Information

- **Robert Koch** gave a **great contribution** to the field of microbiology.
 - **Tuberculosis** was **first discovered** in the year 1882 by Dr. Robert Koch.
 - He **discovered cholera's** livelihoods in 1883 after which he was awarded the **Nobel Prize in 1905**.
 - **Robert Koch** is considered the '**father of microbiology**' due to studies on microbes.
- **Pearl Louella Kendrick** was an **American bacteriologist** and he was famous for **co-developing the first vaccine** with Grace Eldering and Loney Gordon for **whooping cough**.
- **Alexander Fleming** was a Scottish physician-scientist who **discovered penicillin**.

43. Answer: d

Explanation:

The correct answer is B.

- Podophyllum is an **endangered Indian medicinal plant** .

★ Important Points

- **Opium** , the **narcotic drug** that is obtained from the unripe seedpods of the opium poppy.
 - "**Morphine**" is found in **opium** , which is processed into a narcotic drug called heroin.
- Basil is a '**dicot**' and **medicinal** plant.
- Basil is also known as tulsi.
 - Even in Ayurveda, Tulsi is considered a **plant rich in medicinal properties**.
 - The botanical name of Tulsi is '**Ocimum sanctum Linn**' .

44. Answer: c

Explanation:

Concept used:

Follow **BODMAS** rule to solve this question, as per the order given below,

B	Brackets in order (), {}, []	ब्रैकेट (), {}, [] क्रम में
O	of	का
D	Division (÷)	विभाजन (÷)
M	Multiplication (×)	गुणा (×)
A	Addition (+)	जोड़ (+)
S	Subtraction (-)	घटाव (-)

Calculation:

$$3668 \div 524 - 9$$

$$\Rightarrow 3668/524 - 9$$

$$\Rightarrow 7 - 9$$

$$\therefore -2$$

45. Answer: a

Explanation:

Given:

We have to find HCF of 4432, 3324

Calculation:

Factors of 4432

2	4432
2	2216
2	1108
2	554
	277

$$\Rightarrow 4432 = 2 \times 2 \times 2 \times 2 \times 277$$

$$\Rightarrow 2^4 \times 277$$

Factors of 3324

2	3324
2	1662
3	831
	277

$$\Rightarrow 3324 = 2 \times 2 \times 3 \times 277$$

$$\Rightarrow 2^2 \times 3 \times 277$$

$$\text{HCF}(4432, 3324)$$

$$\Rightarrow 2^2 \times 277$$

$$\Rightarrow 1108$$

\therefore The HCF of 4432, and 3324 is 1108.

46. Answer: a

Explanation:

Given,

Statement:

All countries are districts

Some villages are not districts

Conclusions:

1. All countries are villages
2. Some countries are villages
3. Some villages are not countries

4. Some countries are not villages

The least possible Venn diagram for the given statements is as follows,

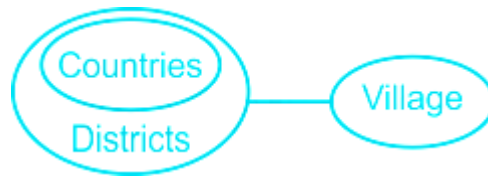

Conclusions:

1. All countries are villages → False (It is possible but not definite)
2. Some countries are villages → False (It is possible but not definite)
3. Some villages are not countries → False (It is possible but not definite)
4. Some countries are not villages → False (It is possible but not definite)

Hence, the correct answer is **A. None follow.**

47. **Answer: b**

Explanation:

Given:

Length of rectangle = 6 cm

Width of rectangle = 2 cm

Formula used:

Pythagoras theorem

$$\text{hypotenuse}^2 = \text{perpendicular}^2 + \text{base}^2$$

Calculation:

Let the diagonal be 'd'.

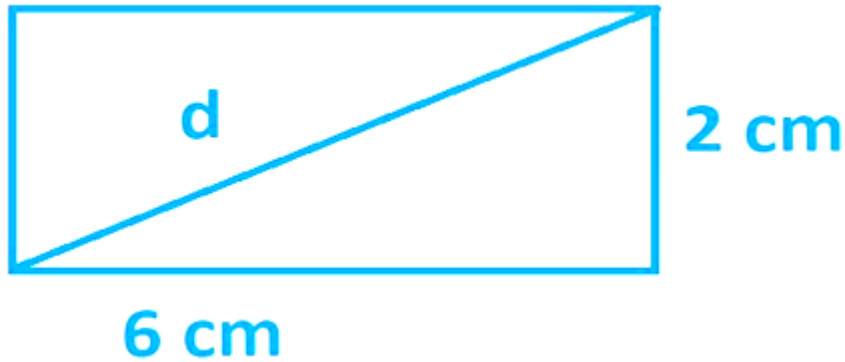

$$\Rightarrow d^2 = \text{length}^2 + \text{width}^2$$

$$\Rightarrow d^2 = 6^2 + 2^2$$

$$\Rightarrow d^2 = 36 + 4$$

$$\Rightarrow d^2 = 40$$

$$\Rightarrow d = \sqrt{40}$$

$$\Rightarrow d = 2\sqrt{10} \text{ cm}$$

\therefore The diagonal of the rectangle is $2\sqrt{10}$ cm.

prepp
Your Personal Exams Guide

48. Answer: c

Explanation:

Given,

If '+' is 'x', '-' is '+', 'x' is '÷' and '÷' is '-'

$$21 \div 8 + 2 - 12 \times 3 = ?$$

$$\therefore 21 - 8 \times 2 + 12 \div 3 = 21 - 16 + 4 = 9$$

Hence, the correct answer is 9.

49. Answer: a

Explanation:

Given:

Ratio of two numbers = 2 : 9

HCF = 32

Concept used:

(i) If a and b are two numbers, then $a \times b = \text{HCF} \times \text{LCM}$

(ii) HCF of two numbers is the highest common factor of both of them.

Calculations:

Let the numbers be $2x$ and $9x$.

Then, H.C.F. = x

As we have given, $x = 32$

First number is $2x$.

$$\Rightarrow 2 \times 32 = 64$$

Second number is $9x$.

$$\Rightarrow 9 \times 32 = 288$$

$$a \times b = \text{HCF} \times \text{LCM}$$

$$\Rightarrow 64 \times 288 = 32 \times \text{LCM}$$

$$\Rightarrow \text{LCM} = 576$$

\therefore The LCM is 576.

50. Answer: a

Explanation:

Given:

Cheating percent while buying and selling = 12%

Formula Used:

$$\text{Profit \%} = \left[\frac{(\text{S.P} - \text{C.P})}{\text{C.P}} \times 100 \right]$$

Calculation:

Shopkeeper buy 112 gm goods instead of 100 gm by cheating

And he sells 88 gm instead of 100 gm

According to the question

$$\text{SP/CP} = \frac{(112 \times 100)}{(100 \times 88)}$$

$$\Rightarrow 14/11$$

$$\text{Profit} = \text{SP} - \text{CP}$$

$$\Rightarrow 14 - 11 = 3$$

$$\text{Profit Percentage} = \left(\frac{3}{11} \right) \times 100\%$$

$$\Rightarrow 27.27\%$$

∴ The shopkeeper earned 27.27 % profit.

 Alternate Method

Shopkeeper cheats 12% in weight while buying as well as selling

$$\text{Cost price for shopkeeper} = [100 \times (100 - 12)]/100$$

$$\Rightarrow 88$$

$$\text{Selling price for shopkeeper} = [100 \times (100 + 12)]/100$$

$$\Rightarrow 112$$

$$\text{Profit \%} = [(S.P - C.P)/C.P] \times 100\%$$

$$\Rightarrow [(112 - 88)/88] \times 100\%$$





$$\Rightarrow (24/88) \times 100\%$$

$$\Rightarrow 27.27\%$$

\therefore The shopkeeper earned 27.27% profit.

51. Answer: a

Explanation:

Symbol in Diagram	Meaning
	Female
	Male
	Married Couple
	Siblings
	Difference of A Generation

Given,

Poorvi introduces Arjuna, as his mother's brother's son.

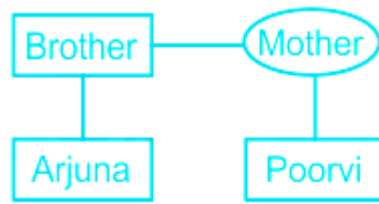

Here we see Poorvi and Arjuna are cousins.

Hence, the correct answer is B. Cousin.

52. Answer: b

Explanation:

Given:

$$5x - 4 = 3 - x$$

Calculation:

$$5x - 4 = 3 - x$$

$$\Rightarrow 5x + x = 3 + 4$$

$$\Rightarrow 6x = 7$$

$$\Rightarrow x = 7/6$$

$$\Rightarrow x = 1\frac{1}{6}$$

\therefore The value of x is $1\frac{1}{6}$.

53. Answer: d

Explanation:

The correct answer is A.

- The **Portuguese** were the first to reach India from Europe, followed by the Dutch.
- On **17 May 1498**, '**Vasco da Gama**' of Portugal arrived on the coast of India (**Calicut, Kerala**). At that time the king of this place was '**Zamorin**'.
- In 1500, the Portuguese built their **first business cell near 'Cochin' (Kerala)**.

★ Additional Information

- In **1510**, the Portuguese **took over Goa** and made it their '**administrative center**'.
- **Francisco de Almeida (1505 AD)** became the first Portuguese Viceroy in India.
- '**Alphonso de Albuquerque**' became Portuguese Viceroy (1509 AD) in India.
- The **order of arrival of a European company** in India is as follows-
- Portuguese ⇒ Dutch ⇒ English ⇒ Danish ⇒ French.

54. Answer: d

Explanation:

The correct answer is A.

- The '**FIFA U-17 World Cup 2015**' was held in '**Chile**'.
- In the final match, '**Nigeria**' defeated '**Mali**' by 2.0 to **win the World Cup Championship**.
- Nigeria's '**Victor Osimane**', who scored the most 10 goals in the competition, has been awarded the '**Golden Boot**' award.
- The best player in the competition, '**Kelechi Nakali**' (**Nigeria**), was awarded the Golden Bal award.

★ Additional Information

- The **FIFA U-17 World Cup 2017** was held in India. In which '**England**' won the World Cup Championship.

- The **FIFA U-17 World Cup 2019** was **held in Brazil** . In which '**Brazil**' won the World Cup Championship.
- The next **FIFA U-17 World Cup** will be **held in Peru**.
- The **FIFA (Federation Internationale Football Association)** headquartered is located in **Zurich, Switzerland**.

55. **Answer: a**

Explanation:

Given,

Statement:

1. Satyavan is not Harish's father
2. Harish is the son of Suraj
3. Suraj has three sons

Choose the correct conclusion

- A. Satyavan is the son of Suraj
- B. Harish is the brother of Satyavan
- C. Suraj is Harish's father
- D . Satyavan has no child

Here we see 'Suraj is Harish's father' is the only correct conclusion.

Hence, the correct answer is **C. Suraj is Harish's father**.

56. **Answer: d**

Explanation:

Given:

$$21212 \times 9999$$

Calculations:

$$21212 \times 9999$$

$$\Rightarrow 21212 \times (10000 - 1)$$

$$\Rightarrow 212120000 - 21212$$

$$\Rightarrow 212098788$$

\therefore The answer is 212098788.

57. Answer: c

Explanation:

The correct answer is D.

- Osmosis is a 'special diffusion process', which occurs through a semipermeable membrane.
- In this, solvent molecules move from a low concentration solution to a high concentration solution.
- This is a physical action.

★ Additional Information

- **Reverse osmosis** is a technique of purifying water that uses a partially permeable membrane to separate ions, unwanted molecules, and larger particles from drinking water.
- **Capillarity** – Capillarity is defined as a phenomenon of the rise or fall of a liquid surface in a small tube.

- **Viscosity** – The fluid opposes the relative motion in its various layers, it is called viscosity.

58. Answer: a

Explanation:

Given,



Here we see diagonally opposite images are the same.

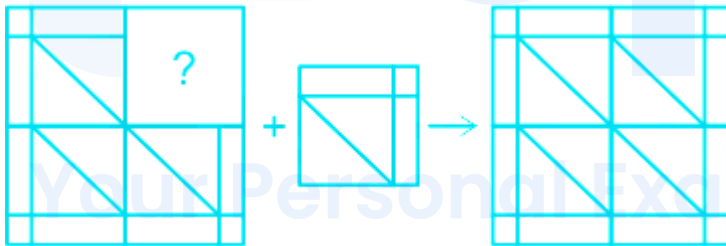

Hence, the correct answer is B. 2.

59. Answer: d

Explanation:

Given:

Total amount = Rs. 95

Ratio of distribution = 2 : 3 : 6 : 8

Calculations:

Let the money divided in four parts be $2x$, $3x$, $6x$ and $8x$.

$$2x + 3x + 6x + 8x = 95$$

$$\Rightarrow 19x = 95$$

$$\Rightarrow x = 5$$

First part = $2x$

$$\Rightarrow 2 \times 5 = \text{Rs. } 10$$

Second part = $3x$

$$\Rightarrow 3 \times 5 = \text{Rs. } 15$$

Third part = $6x$

$$\Rightarrow 6 \times 5 = \text{Rs. } 30$$

Fourth part = $8x$

$$\Rightarrow 8 \times 5 = \text{Rs. } 40$$

\therefore The proportion of rupees is 10, 15, 30 & 40.

60. Answer: b

Explanation:

The correct answer is D.

- "Elizabeth-II" has become the **longest-reigning empress of Britain's monarchy.**
- On 9 September 2015, he broke the record of his grandmother 'Queen Victoria' in terms of governance.

- **Elizabeth-II** was born on 21 April 1926 in London and her husband is '**Prince Philip**'.

★ Additional Information

- **Queen Elizabeth-I** (1533–1603 CE) was the **Queen of England**. The 'British East India Company' was established during these times.
- **Queen Victoria** (24 May 1819 – 22 January 1901) ascended the throne as Queen of Great Britain and Ireland.
- In 1850, the then Governor-General presented the world-famous Kohinoor diamond of India as a gift to 'Queen Victoria'.
- After the death of his father, **Edward-VI**, George was declared '**Maharaja George V**'.
- In 1911, **King George V and Queen Mary** were crowned in the Delhi court in a grand manner.

61. Answer: a

Explanation:

The correct answer is B.

- **Ajanta caves** are located in the **Aurangabad district of Maharashtra**, which was built in the second century BC.
- Around 29 rock-cut '**Buddhist caves**' have been made in these caves.
- Ajanta caves are one of the finest examples of **Buddhist architecture, cave painting, and sculpture painting**.
- These paintings on the walls and ceilings of the caves depict various incidents of the life of Lord Buddha and various Buddhist deities.
- These caves are built in the shape of huge horseshoes by cutting the mountain.
- Ajanta caves were included in the list of World Heritage Site by **UNESCO in the year 1983**.
- It is believed that these caves were constructed during two different periods '**Satavahana and Vakataka**'.

62. Answer: a

Explanation:

Given:

Namrata Time taken

Walking + vehicle = 4 hrs 15 mins

Both ways walking = 5 hrs 30 mins

Calculation:

Namrata time taken for walking for one ways

⇒ $(5 \text{ hrs } 30 \text{ mins}) / 2$

⇒ 2 hrs 45 mins

Namrata time taken from vehicle for one ways

⇒ $(4 \text{ hrs } 15 \text{ mins}) - (2 \text{ hrs } 45 \text{ mins})$

⇒ 1 hrs 30 mins

Namrata time taken from vehicle for both ways

⇒ $(1 \text{ hrs } 30 \text{ mins}) \times 2$

⇒ 3 hrs.

∴ Namrata time taken from vehicle for both ways is 3 hrs.

63. Answer: c

Explanation:

The correct answer is C.

★ Key Points

- Muhammad Ghori was defeated in 1178 by Bhimdev Solanki II, the Chalukya Vanshi king of Gujarat.
- Bhimdev I was the ruler of the Solanki dynasty of Gujarat.
- It ruled Vadnagar from 1021-1073 AD.
- Bhimdev II was the last king of the Rajputs of Gujarat and Chaulkya (Solanki). After this, his minister Lavanaprasad replaced the 'Baghel dynasty' in Gujarat.

★ Additional Information

- Kulottung Chola I was the eminent ruler of the Chola kingdom of South India.
 - He was the son of Chalukyanresh Rajraj Narendra of Vengi.
- Kulottung Chola II was the grandson of Kulottung (I) and the son of Vikram Chola.

64. Answer: b

Explanation:

Given:

Product of two numbers = 1568

LCM = 56

Formula used:

Product of two numbers = LCM × HCF

Calculation:

Product of two numbers = LCM × HCF

⇒ HCF × 56 = 1568

⇒ HCF = 1568/56

⇒ HCF = 28

∴ The HCF is 28.

65. Answer: d

Explanation:

The correct answer is B.

★ Key Points

- The 'All India Forward Block' Party was established in 1939 by Netaji Subhash Chandra Bose.
- Subhash Chandra Bose, the great hero of the freedom movement was born on 23 January 1897.
- His famous slogan was 'You give me blood, I'll give you freedom'.
- The Indian National Congress is a major political party in India and was established in 1885 in Bombay.

★ Additional Information

- Samajwadi Party is active in Uttar Pradesh. It was established on October 8, 1992.
- Samajwadi Party founder and patron are Mulayam Singh Yadav.

66. Answer: b

Explanation:

Given:

Sample size = 60

$$\sum x^2 = 18000, \sum x = 960$$

Formula used:

$$\text{Variance} = \frac{1}{n} \sum x^2 - \left(\frac{\sum x}{n} \right)^2$$

Where,

n = sample rate

Calculation:

Variance

$$\Rightarrow (1/60) \times 18000 - (960/60)^2$$

$$\Rightarrow 300 - (16)^2$$

$$\Rightarrow 300 - 256$$

$$\Rightarrow 44$$

∴ The variance is 44.

67. Answer: d

Explanation:

The incorrect pair is **Biology: Botany**.

★ Key Points

- **Ornithology:**
 - Ornithology is a branch of zoology that concerns the "methodological study and consequent knowledge of birds with all that relates to them".
Hence, pair A is correct .
- **Mycology:**
 - It is the branch of biology concerned with the study of fungi, including their genetic and biochemical properties, their taxonomy, and their use to

humans as a source for tinder, traditional medicine, food, and entheogens, as well as their dangers, such as toxicity or infection. **Hence, pair B is correct .**

- **Phycology:**

- It is the scientific study of algae.
- Also known as algology, phycology is a branch of life science. **Hence, pair D is correct .**

★ Confusion Points

- **Biology:**

- It is the natural science that studies life and living organisms, including their physical structure, chemical processes, molecular interactions, physiological mechanisms, development, and evolution.

- **Botany:**

- It is also called plant science, plant biology, or phytology is the science of plant life and a branch of biology.

Hence, pair c is incorrect .

68. Answer: b

Explanation:

The correct answer is C.

★ Key Points

- **Nitrous oxide**, known as **laughing gas** , is used as an anesthetic by dentists.
- The chemical formula is N_2O .
- It is a colorless non-flammable gas, with a slight metallic scent and taste at room temperature,
- Nitrous oxide can be used to treat pain. It also functions as a mild sedative.
- Nitrogen is represented by the "N" symbol, which is present in abundant quantity (78%) in the environment.

★ Additional Information

- **Oxygen** is colorless, tasteless, and odorless gas.
 - In 1682 AD '**Carl Scheele**' prepared oxygen gas by heating potassium nitrate.
- **Chlorine** is a chemical element, which has an atomic number of "17" and the symbol "Cl".
 - **Chlorine** was discovered by "**Shale**" in 1774.

69. Answer: a

Explanation:

Given:

$$\sin A = \frac{15}{17} \text{ and } \sin B = \frac{7}{25}$$

Formula used:

$$\sin(A - B) = \sin A \cos B - \cos A \sin B$$

Calculation:

$$\sin A = \frac{15}{17}, \text{ then } \cos A = \frac{8}{17}$$

$$\sin B = \frac{7}{25}, \text{ then } \cos B = \frac{24}{25}$$

$$\sin(A - B) = \sin A \cos B - \cos A \sin B$$

$$\Rightarrow (15/17) \times (24/25) - (8/17) \times (7/25)$$

$$\Rightarrow (72/85) - (56/425)$$

$$\Rightarrow (360 - 56)/425$$

$$\Rightarrow 304/425$$

∴ The value of $\sin(A - B)$ is $304/425$.

70. Answer: b

Explanation:

The correct answer is A.

★ Key Points

- The **blue and white** are used for tsunami warning signs in **New Zealand**.
- Colors can be divided into three parts - **Primary color or base color, a secondary color, and anti-color**.
- Primary colors or basic colors are colors that cannot be obtained by mixing, such as **red, blue, and green**.
- **Secondary colors** are colors that are obtained by mixing two primary colors.
- The colors that are formed by mixing primary and secondary colors are called opposing colors.
- For example, the opposing color of blue is '**yellow**', and the opposing color of purple is '**parrot color**'.

Your Personal Exams Guide

71. Answer: a

Explanation:

Given:

Rajneesh speed 6 km/h, 4 km/h, 8 km/h.

Total time = 32.5 minutes

Formula used:

Speed = Distance/Time

Calculation:

Let the distance be 'x' km.

Total time taken

$$\Rightarrow (x/6) + (x/4) + (x/8) \text{ hr} = 32.5 \text{ minutes}$$

$$\Rightarrow (13x/24) \text{ hr} = 32.5 \text{ minutes}$$

$$\Rightarrow (13x/24) \times 60 \text{ minutes} = 32.5 \text{ minutes}$$

$$\Rightarrow x = 1 \text{ km}$$

Total distance covered

$$\Rightarrow 1 + 1 + 1$$

$$\Rightarrow 3 \text{ km}$$

\therefore The total distance is 3 km.

72. Answer: d

Explanation:

The correct answer is B.

★ Key Points

- "Bit" is the **smallest unit** in computer information systems.
 - 1 byte contains 8 bits.
 - 1,024 Byte = 1 Kilo Byte (KB)
 - 1024 KB Byte = 1 MB
 - 1024 MB = 1 GB
 - 1024 GB = 1 TB
 - 1024 TB = 1 PB
 - 1024 PB = 1 EB

- 1024 EB = 1 ZB
-

73. Answer: b

Explanation:

Given:

Aayush and Lohit together can finish in 17 days.

Lohit efficiency = $2 \times$ Aayush efficiency

Calculation:

Lohit efficiency = 2

Aayush efficiency = 1

Lohit + Aayush Efficiency

$\Rightarrow 2 + 1 = 3$

Aayush and Lohit together can finish in 17 days

Total work

$\Rightarrow 17 \times 3$

$\Rightarrow 51$

Aayush can finish alone

$\Rightarrow 51/1$

$\Rightarrow 51$ days

\therefore Aayush can finish alone in 51 days.

74. Answer: b

Explanation:

The correct answer is A.

★ Key Points

- The equator passes through the **Indonesian city of Pontianak** (the capital of the province).
- The equator passes through a total of **13 countries**, they are -
 - **Countries of South America continent** - Ecuador, Colombia, and Brazil.
 - **Countries of the continent of Africa** - Gabon, Republic of Congo, Democratic Republic of Congo, Uganda, Kenya, Somalia, Saotome and Principe (Island)
 - **Countries on the continent of Asia** - Maldives, Indonesia, Kiribati

★ Additional Information

- The equator is a line which divides the earth in two equal part.
- The Equator is the line of **0 degrees latitude**.

75. Answer: d

Explanation:

Given,

Statement:

1. Nobody else but only the poor can spend on rickshaws.
2. Some people travelling by rickshaw become ill.
3. Some of those who become ill require treatment.

Conclusions:

- A. All poor people travel by rickshaw → False
- B. People who travel by rickshaw become ill → False
- C. All poor people become ill → False
- D. All those who travel by rickshaw are poor → True

Here we see only conclusion D is correct.

Hence the correct answer is D. All those who travel by rickshaw are poor.

76. Answer: d

Explanation:

The correct answer is A.

★ Key Points

- Antiseptic is a substance, that **prevents the spread of bacteremia or reduces its effects**.
- The soap has antiseptic properties due to '**Bithional**'.
- Soaps are generally sodium salts of **high fat-acids**.
- . Bithional is an aromatic compound.

★ Additional Information

- **Sodium laurel sulfate (SAS)** is an **organic compound** used in toothpaste and cosmetics.
 - Sodium dodecyl benzenesulfonate is a type of **detergent**.
 - **Rosin** is a **solid form** of resins. Rosin is obtained as a by-product in the manufacture of turpentine oil.
-

77. Answer: b

Explanation:

We know,

Given,

AKASH is coded as 29208 and BRIJESH is coded as 1536708

The pattern followed here is,

A = 2, K = 9, A = 2, S = 0, H = 8

and,

B = 1, R = 5, I = 3, J = 6, E = 7, S = 0, H = 8

Similarly,

SHABIR is coded as,

S = 0, H = 8, A = 2, B = 1, I = 3, R = 5

∴ SHABIR is coded as 082135.

Hence, the correct answer is 082135.

Your Personal Exams Guide

78. Answer: a

Explanation:

Given:

Amit sells the bus at a loss of 15% for Rs. 23,800. He needs to get a profit of 15%

Concept Used:

Selling price = Cost price - loss

Calculation:

Let the cost price of the bus be x

$$\text{Loss} = 15x/100$$

The selling of the bus is $(x - 15x/100)$

$$\Rightarrow 85x/100$$

$$\Rightarrow 17x/20$$

Accordingly,

$$17x/20 = 23800$$

$$\Rightarrow x = (23800 \times 20)/17$$

$$\Rightarrow x = 28000$$

The cost price of the bus is Rs. 28000

He wants to get 15% profit.

$$\text{Profit should be } (15/100) \times 28000$$

$$\Rightarrow 4200$$

The selling price of the bus should be $(28000 + 4200)$

$$\Rightarrow 32200$$

\therefore At Rs. 32200 he should sell the bus to get 15% profit.

79. Answer: b

Explanation:

Given,

'Five students - Anil, Baruna, Chitra, Dave, and Elsa - represent their schools in five different sports such as cricket, football, basketball, badminton and kabaddi.

Anil plays football.

Baruna and Dave do not play badminton or cricket.

Chitra does not play kabaddi.

Elsa does not play cricket, basketball or kabaddi.

Student	Game	Does not play the game
Anil	Football	
Baruna	Basketball/ Kabaddi	Badminton, Cricket
Chitra	Cricket	Kabaddi
Dave	Basketball/ Kabaddi	Badminton, Cricket
Elsa	Badminton	Cricket, Basketball, Kabaddi

Here we see Chitra play cricket.

Hence, the correct answer is C. Chitra.

80. Answer: b

Explanation:

Given,

'Five students - Anil, Baruna, Chitra, Dave, and Elsa - represent their schools in five different sports such as cricket, football, basketball, badminton and kabaddi.

Anil plays football.

Baruna and Dave do not play badminton or cricket.

Chitra does not play kabaddi.

Elsa does not play cricket, basketball or kabaddi.

Student	Game	Does not play the game
Anil	Football	
Baruna	Basketball/ Kabaddi	Badminton, Cricket
Chitra	Cricket	Kabaddi
Dave	Basketball/ Kabaddi	Badminton, Cricket
Elsa	Badminton	Cricket, Basketball, Kabaddi

Here we see we don't know anything about Baruna.

Hence, the correct answer is **D. Cannot be determined.**

81. Answer: d

Explanation:

Given,

'Five students - Anil, Baruna, Chitra, Dave, and Elsa - represent their schools in five different sports such as cricket, football, basketball, badminton and kabaddi.

Anil plays football.

Baruna and Dave do not play badminton or cricket.

Chitra does not play kabaddi.

Elsa does not play cricket, basketball or kabaddi.

Your Personal Exams Guide

Student	Game	Does not play the game
Anil	Football	
Baruna	Basketball/ Kabaddi	Badminton, Cricket
Chitra	Cricket	Kabaddi
Dave	Basketball/ Kabaddi	Badminton, Cricket
Elsa	Badminton	Cricket, Basketball, Kabaddi

Here we see Elsa play Badminton.

Hence, the correct answer is **C. Elsa**.

82. Answer: d

Explanation:

★ Key Points

- "Rickets" is a disease caused by vitamin "D" deficiency.
- Due to its deficiency, calcium and phosphorus are not synthesized in the body.
- Rickets is a bone disease that usually occurs in children.

- Weak bones in children are called '**rickets**'.
- The source of **vitamin D** is sunlight, the **yellow part of the egg, fish oil, milk, and butter**.
- The chemical names of vitamins D and A are '**calciferol and retinal**', respectively.
- The chemical names of vitamins B and K are '**thiamine and phyloquinone**' respectively.
- Night blindness happens due to a lack of vitamin A.
- **Scurvy** is a disease that happens due to a deficiency of Vitamin C.
- **Beriberi** is a disease that happens due to a deficiency of Vitamin B.

★ Mistake Points

- The vitamins are given as **statements alphabetically (A-D)** and the **options are marked numerically (1-4)** for the statements.
- We need to **choose the correct option number** that has the corresponding correct vitamin.
- So the **correct option is (4)** which states 'B' and this 'B' indicates 'vitamin D' in the given statements.

83. Answer: d

Explanation:

The correct answer is D.

★ Key Points

- The modem is a **network hardware device** that **converts digital signals into analog signals** and analog signals into digital signals.
- The modem connects the computer or router to the broadband network.
- Full-Form of Modem is - '**Modulator-Demodulator**'.

★ Additional Information

- **The printer** is an '**Output device**' and the Keyboard is an '**Input device**'.
- A central processing unit (CPU), is also called a '**central processor**'.

- The CPU **processes** the input data so it is called 'computer brain'

84. Answer: c

Explanation:

The correct answer is D.

★ Key Points

- "Days of Grace" is an autobiography by tennis player **Arthur Ashe (1943-1993)**.
- **Arthur Ashe** was an **American tennis player** who won three Grand Slam singles titles.

★ Additional Information

- Chris Evert was an outstanding **American tennis player** who was famous for popularizing the **two-handed backhand stroke**.
- **Christine Marie Evert** (born December 21, 1954), known as **Chris Evert Lloyd** from **1979 to 1987**, is a retired American world No. 1 tennis player
- **John McEnroe** is a former professional American tennis player. He was famous for his shot-making artistry and volleying skills.

85. Answer: c

Explanation:

Given:

Given numbers are $\frac{5}{6}$, $\frac{11}{12}$ and $\frac{8}{9}$

Calculation:

LCM of 6, 12 and 9 is 36

$$\frac{5}{6} \Rightarrow \frac{5 \times 6}{6 \times 6} \Rightarrow \frac{30}{36}$$

$$\frac{11}{12} \Rightarrow \frac{11 \times 3}{12 \times 3} \Rightarrow \frac{33}{36}$$

$$\frac{8}{9} \Rightarrow \frac{8 \times 4}{9 \times 4} \Rightarrow \frac{32}{36}$$

From 30, 33 and 32 arranging them in ascending order get $30 < 32 < 33$

\therefore The required ascending order is $\frac{5}{6}, \frac{8}{9}, \frac{11}{12}$

86. Answer: d

Explanation:

Given,

Statement:

All bottles are pencils

No pencil is school

Conclusions:

1. Some bottles are not school
2. Some schools are not bottles
3. Some pencils are school

The least possible Venn diagram for the given statements is as follows,

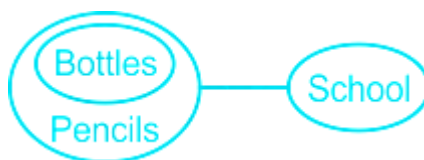

Conclusions:

1. Some bottles are not school \rightarrow True

2. Some schools are not bottles → True

3. Some pencils are school → False (From Venn diagram we see No pencils are a school)

Hence, the correct answer is **D**

87. Answer: b

Explanation:

The correct answer is **D**.

- Such an area where the water of the river gets into the sea and the saline water of the sea enters the river in the 'state of the tide' is called the "**Estuary**".
 - The **estuary built**s at a place where the **river sediment brings very little**.
 - The place where river water meets the ocean and large quantities of sediments are deposited at the joining place. That place is called delta. Such as the Ganges River and Brahmaputra delta in India.
 - **Lagoons** are the **shallow body of water** which got separated from a larger body of water by **some barrier or reefs**.
 - When a Waterfield where it is touched by the sea on one side but surrounded by land on three sides is called a bay. Such as The Bay Bengal.
 - A gulf is a "**large body**" of water that is surrounded by land and having only a "**narrow entrance**".
 - A strait is a "**narrow waterway**" that connects 'two large water bodies'.
-

88. Answer: d

Explanation:

The correct answer is **D**.

★ Key Points

- The '**light-emitting diode**' is used in electronic devices.
- The light-emitting diode (light-emitting diode) is a '**semiconductor diode**'.
- It emits light when currents flow in LEDs.
- It emits narrow bandwidth of either **visible light at different coloured wavelengths, invisible infra-red light for remote controls or laser type light when a forward current is passed through them.**
- It has similar electrical characteristics to a **PN junction diode**. they have very similar electrical characteristics to a PN junction diode.

★ Additional Information

- **Ultraviolet rays** are a type of **electromagnetic radiation** . The **ozone layer protects** the earth and the organisms from the sun's deadly ultraviolet rays.
- **X-rays or X-rays** are a type of **electromagnetic radiation** , the wavelength of X-rays is shorter than ultraviolet rays and longer than gamma rays.
- **Radio waves** are electromagnetic waves whose wavelengths are between 10 cm to 100 km.

89. Answer: b

Explanation:

We know,

Given,

TIGER is coded as UJHFS

The pattern followed here is,

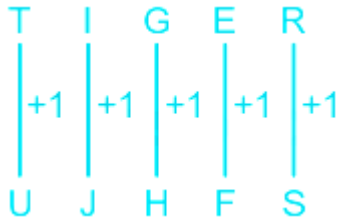

Similarly,

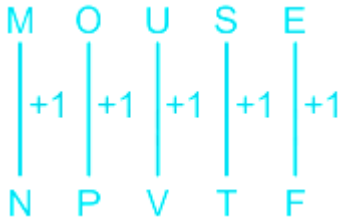

Hence, the correct answer is C. NPVTF.

90. Answer: b

Explanation:

Given:

Value of each external angle = 120°

Formula used:

$$\theta = 360^\circ/n$$

where,

θ = Each external angle

n = Number of sides

Calculations:

$$\theta = 360^\circ/n$$

$$\Rightarrow 120^\circ = 360^\circ/n$$

$$\Rightarrow n = 3$$

\therefore The number of sides is 3.

91. Answer: c

Explanation:

Given,

SHILPA is coded as 841352 and SUNIL is coded as 86913

The pattern followed here is,

$$S = 8, H = 4, I = 1, L = 3, P = 5, A = 2$$

and

$$S = 8, U = 6, N = 9, I = 1, L = 3$$

Similarly,

ANIL is coded as,

$$A = 2, N = 9, I = 1, L = 3$$

$$\therefore \text{ANIL} = 2913$$

Hence, the correct answer is 2913.

92. Answer: b

Explanation:

The correct answer is A.

★ Key Points

- **Kilimanjaro mountain** is the **highest mountain in Africa** it is located in northeastern Tanzania.
- The official capital of Tanzania is '**Dodoma**' and the '**Shilingi**' is the currency of Tanzania.

★ Additional Information

- **Nigeria** is a major country in **West Africa**. The country has the largest population in the entire continent of Africa.
 - '**Abuja**' is the **capital of Nigeria** and the official currency of Nigeria is the '**Naira**'.
- The Republic of Ghana is a country located in **West Africa** and its capital is '**Accra**'.
- **South Africa** is a country on the continent of Africa and '**Pretoria**' is the administrative capital of the country.

93. Answer: c

Explanation:

Given:

Number of candidates who appeared from State M in 1997 = 5200

Number of candidates who appeared from State M in 1998 = 8500

Number of candidates who appeared from State M in 1999 = 7400

Number of candidates who appeared from State M in 2000 = 6800

Number of candidates who appeared from State M in 2001 = 9500

Formula used:

Average = Sum of Values / Number of values

Calculations:

$$\text{Average} = (5200 + 8500 + 7400 + 6800 + 9500) / 5$$

$$\Rightarrow 37400 / 5$$

$$\Rightarrow 7480$$

\therefore The average number of candidates who appeared from State M during the given years is 7480.

94. Answer: c

Explanation:

Given:

Number of candidates who appeared from State R in 1997 = 7800

Number of candidates who appeared from State R in 1998 = 7600

Number of candidates who appeared from State R in 1999 = 9800

Number of candidates who appeared from State R in 2000 = 7600

Number of candidates who qualified from State R in 1997 = 870

Number of candidates who qualified from State R in 1998 = 940

Number of candidates who qualified from State R in 1999 = 1350

Number of candidates who qualified from State R in 2000 = 945

Calculations:

Percentage of qualified candidates out of the number of candidates present of state

$$R \text{ in } 1997 = (870 / 7800) \times 100$$

⇒ 11.15%

Percentage of qualified candidates out of the number of candidates present of state R in 1998 = $(940/7600) \times 100$

⇒ 12.37%

Percentage of qualified candidates out of the number of candidates present of state R in 1999 = $(1350/9800) \times 100$

⇒ 13.77%

Percentage of qualified candidates out of the number of candidates present of state R in 2000 = $(945/7600) \times 100$

⇒ 12.43%

∴ Year 1999 has the maximum percentage of qualified candidates out of the number of candidates present of state R.

95. Answer: c

Explanation:

Given:

Number of applications of candidates from State M in 2000 = 6800

Number of applications of candidates from State N in 2000 = 9200

Number of applications of candidates from State P in 2000 = 8750

Number of applications of candidates from State Q in 2000 = 9700

Number of applications of candidates from State R in 2000 = 7600

Number of applications of candidates from State M in 2001 = 9500

Number of applications of candidates from State N in 2001 = 8800

Number of applications of candidates from State P in 2001 = 9750

Number of applications of candidates from State Q in 2001 = 8950

Number of applications of candidates from State R in 2001 = 7990

Calculations:

Total number of applications of candidates from all states in the year 2000 = 6800 + 9200 + 8750 + 9700 + 7600

⇒ 42,050

Total number of applications of candidates from all states in the year 2001 = 9500 + 8800 + 9750 + 8950 + 7990

⇒ 44,990

Percentage = $(42,050/44,990) \times 100$

⇒ 93.4%

∴ The total number of applications of candidates from all states in the year 2000 is approximately 93.4% of the total number of applications of candidates from all states in the year 2001.

Your Personal Exams Guide

96. Answer: b

Explanation:

Given :

The given data = $1, \frac{1}{2}, \frac{1}{2}, \frac{3}{4}, \frac{1}{4}, 2, \frac{1}{2}, \frac{1}{4}, \frac{3}{4}$

Formula:

The mode of a set of data values is the value that appears most often.

Calculation:

Mode of the data = $1/2$

$\therefore 1/2$ appears most often (3 times).

97. Answer: b

Explanation:

★ Alternate Method

Rate for 6 months = $20/4 = 5\%$

Equivalent years = $6/3 = 2$

Equivalent rate of interest = $5 + 5 + (5 \times 5)/100 = 10.25\%$

Compound interest = $13000 \times 10.25/100 = 1332.5$

Amount = $13000 + 1332.5 = \text{Rs. } 14332.5$

Traditional method:

Given: **Your Personal Exams Guide**

$P = \text{Rs. } 13000$

$r = 20\%$

$t = 6$ months

Formula:

If interest compounded quarterly, then

$r = 20/4 = 5\%$

$t = 6/12 \times 4 = 2$ years

Calculation:

$$CI = P [(1 + r/100)^t - 1]$$

$$\Rightarrow CI = 13000[(1 + 5/100)^2 - 1]$$

$$\Rightarrow CI = 13000 \times [105/100 \times 105/100 - 1]$$

$$\Rightarrow CI = 13000 \times (11025 - 10000)/10000$$

$$\Rightarrow CI = 13 \times 1025/10$$

$$\Rightarrow CI = \text{Rs. } 1332.5$$

The maturity amount = 13000 + 1332.5 = Rs. 14332.5

98. Answer: b

Explanation:

The least possible Venn diagram for the given statements is as follows,







Conclusions:

1. Some books are mice → True (as "all rats are books and all rats are mice" given so some books can be mice it is definite, hence, true)
2. All books are mice → False (as "all rats are books and all rats are mice" given so some books can be mice but all books can never be mice, hence, false)
3. Some mice are not rats → False (as "all rats are mice" positive statement given so negative conclusion is always false)

Hence, the correct answer is "A. Only 1 follow".

★ Additional Information

Statement	Conclusion		
	Definite (100% true)	Can't Say	Incorrect (100% false)
All A are B 	Some A are B Some B are A	Some B are not A All B are A	Some A are not B No A is B No B is A
Some A are B 	Some B are A	Some A are not B All B are A Some B are not A All A are B	No A is B No B is A
No A is B 	No B is A Some A are not B Some B are not A		Some A are B Some b are A All A are B All B are A
Some A are not B 		Some B are not A Some A are B Some B are A All B are A No A is B No B is A	All A are B

99. Answer: c

Explanation:

The correct answer is B.

★ Key Points

- Savarkar composed the epics 'Kamala' and 'Gomantak' while living in the Cellular Jail during the sentence of Kalapani in Andaman.
- Vinayak Savarkar was born in Maharashtra, he was a great revolutionary.
- VD Savarkar had established a revolutionary organization called 'Abhinav Bharat'.
- Savarkar wrote the famous book 'History of the War of Indian Independence' based on the revolution of 1857.
- Under the "Nashik Conspiracy Case", he was sent to 'Cellular Jail' on 8 April 1911 on the sentence of 'Kala Pani'.

★ Additional Information

- Mahamana Madan Mohan Malaviya was the founder of 'Kashi Hindu University' in 1916.
- Batukeshwar Dutt was the great revolutionary of India's freedom struggle.

100. Answer: c

Explanation:

$$4^{-3/2} = ?$$

$$2(2 \times -3/2) = ?$$

$$2(-3) = ?$$

$$1/2 \cdot 3 = ?$$

$$1/8 = ?$$