

Engineering Services (Main)  
Examination - 2025

वियोज्य **DETACHABLE**

**ELECTRICAL ENGINEERING**  
**Paper II**

Time Allowed : Three Hours

Maximum Marks : 300

**QUESTION PAPER SPECIFIC INSTRUCTIONS**

Please read each of the following instructions carefully before attempting questions.

There are **EIGHT** questions divided in **TWO** Sections.

Candidate has to attempt **FIVE** questions in all.

Questions No. **1** and **5** are **compulsory** and out of the remaining, **THREE** are to be attempted choosing at least **ONE** question from each Section.

The number of marks carried by a question/part is indicated against it.

Wherever any assumptions are made for answering a question, they must be clearly indicated.

Diagrams/Figures, wherever required, shall be drawn in the space provided for answering the question itself.

Unless otherwise mentioned, symbols and notations have their usual standard meanings.

Attempts of questions shall be counted in sequential order. Unless struck off, attempt of a question shall be counted even if attempted partly.

Any page or portion of the page left blank in the Question-cum-Answer Booklet must be clearly struck off.

Answers must be written in **ENGLISH** only.

## SECTION 'A'

- 1.(a) Give the circuit diagram of a negative peak clamper circuit using op-amp, and
- (i) Considering  $V_{ref} = +2$  V, sketch the output waveform for an input signal  $v_i = 2 \sin(1000 t)$ .
  - (ii) Provide conditions to achieve precision clamping and explain how will you protect op-amp against excessive discharge currents.
  - (iii) State how will you modify your circuit to achieve positive peak clamping.
- 12
- 1.(b) A 7.5 kW, 440 V, 3-phase, star-connected, 50 Hz, 4-pole squirrel cage induction motor develops full load torque at a slip of 3% when operated at rated voltage and frequency. The leakage reactances of stator and rotor windings are five times the respective stator and rotor resistances. The ratio of stator to rotor winding is 3 : 5. Determine the percentage increase in stator reactance to limit starting current to 2.5 times the full load current. Assume  $R_1$  and  $R_2$  are equal and of requisite amount; and motor has negligible magnetising reactance and core losses.
- 12
- 1.(c) In a short-circuit test on a 3-pole, 110 kV circuit breaker, power factor of the fault was 0.4, the recovery voltage was 0.95 times full line value. The breaking current was symmetrical. The frequency of oscillation of restriking voltage was 15,000 cycles/sec. Estimate the average rate of rise of restriking voltage. The neutral is grounded and fault involves earth.
- 12
- 1.(d) The standstill impedances of the inner and outer cages of a double cage 3- $\phi$  induction motor rotor are given as  $Z_{ic} = (0.01 + j 0.5) \Omega$  and  $Z_{oc} = (0.05 + j 0.1) \Omega$  respectively. Assuming the stator impedance to be negligible, determine the approximate ratio of the torques produced by the outer cage ( $T_{oc}$ ) to the torque produced by the inner cage ( $T_{ic}$ ) at a slip of  $s = 0.05$  ? Also determine the net torque developed as a function of  $T_{oc}$  and comment on performance as compared to single cage motor.
- 12
- 1.(e) A 10 MVA, 13.8 kV turbo-generator having  $X_d'' = X_2 = 15\%$  and  $X_0 = 5\%$  is about to be connected to power system. The generator has current limiting reactor of  $0.7 \Omega$  in the neutral. Before the generator is connected to the system, its voltage is adjusted to 13.2 kV. When a double line to ground fault develops at terminal 'b' and 'c', find the initial symmetrical r.m.s. currents in the ground and in line 'b'.
- 12

- 2.(a) A 15 km long 3-phase overhead line delivers 5 MW at 11 kV at a power factor of 0.8 lagging. Line loss is 12% of the power delivered. Line inductance is 1.1 mH per km per phase.

Calculate :

- (i) Sending end voltage and voltage regulation. 15
- (ii) Power factor of the load to make voltage regulation zero. 5
- 2.(b) A 2200/220 V, single phase transformer has maximum possible voltage regulation of 6% and it occurs at a power factor of 0.3 lag. Find the load voltage at full load at a power factor of 0.8 lead. 20
- 2.(c)(i) For the state diagram shown below, design the circuit using *D*-flip flops. Assume  $S_0 : 00$ ,  $S_1 : 10$  and  $S_2 : 01$ .

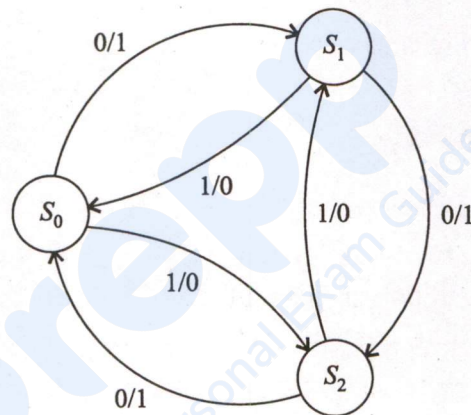

Realize the signal circuits with minimum number of NAND gates (More than two input NAND gates are allowed). 10

- 2.(c)(ii) An angle modulated signal is given as

$$X(t) = 20 \cos(12000 t) \text{ for } |t| \leq 1$$

If the carrier wave frequency  $\omega_c = 10000$  rad/sec, determine

- (A) Modulation index  $m(t)$ , if  $X(t)$  were a PM (phase modulated) signal with  $K_p = 500$  over  $|t| \leq 1$ .
- (B) Modulation index  $m(t)$ , if  $X(t)$  were a frequency modulated (FM) signal with  $K_f = 500$  over  $|t| \leq 1$ . 10

- 3.(a) Give the circuit diagram of a second order highpass Butterworth filter circuit using op-amp. Evaluate the component values, such that the filter has lower cutoff frequency of 5 kHz and a pass band gain  $A_F = 2$ . Also give expression for voltage gain magnitude and sketch its frequency response. 20
- 3.(b) A 50 Hz alternator is supplying 40% of the power that it is capable of delivering through a transmission line to an infinite bus. A fault occurs that increases the reactances between the generator and the infinite bus to 600% of the value before the fault. When the fault is isolated, the maximum power that can be delivered is 80% of the original maximum value, find critical clearing angle. 20
- 3.(c) A 240 V D.C. series motor takes 40 A when giving its rated output at 1500 rpm. Its resistance is  $0.3 \Omega$ . Calculate the value of resistance that must be added to obtain the rated torque

(i) during starting and

(ii) at 1000 rpm

20

- 4.(a) Figure shows a two bus system. If a power of 125 MW is transferred from plant 1 to load, a power loss of 15.625 MW occurs. Find generation schedule and load demand if cost of received power is ₹24 per MWh. The incremental production costs are

$$\frac{dF_1}{dP_1} = 0.025 P_1 + 15$$

$$\frac{dF_2}{dP_2} = 0.05 P_2 + 20$$

Assume penalty factor of 2nd generator = 1.

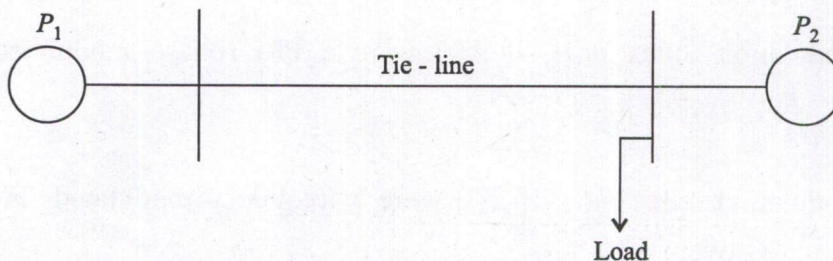

20

- 4.(b)(i) Give the block diagram of AM Receiver and FM Receiver. Also explain each block. 10
- 4.(b)(ii) What is the largest value of output voltage from an 8-bit DAC that produces 2.0 V for digital Input of 01110010 ? 10
- 4.(c) A 3-phase, 6-pole, 500 kVA, 6600 V, 50 Hz star-connected synchronous motor having synchronous impedance of  $j 80 \Omega$  per phase operates at unity power factor at rated conditions.
- (i) Determine the mechanical torque driving capability for this motor at rated conditions, neglecting all mechanical losses.
  - (ii) At this rated torque, what are the required deviations from rated armature current and excitation (in terms of  $E_f \angle \delta$ ) to produce a maximum torque of 1.26 times to the maximum rated torque for a leading power factor operation of motor.
  - (iii) Determine the value of the leading power factor for motor operation as stated in (ii) above. 20

### SECTION 'B'

- 5.(a) An exponential function  $f(t) = e^{-3t} u(t)$  as shown in the following figure is delayed by 1 sec. Sketch and describe mathematically the delayed function. Also repeat the same if  $f(t)$  is advanced by 1 second.

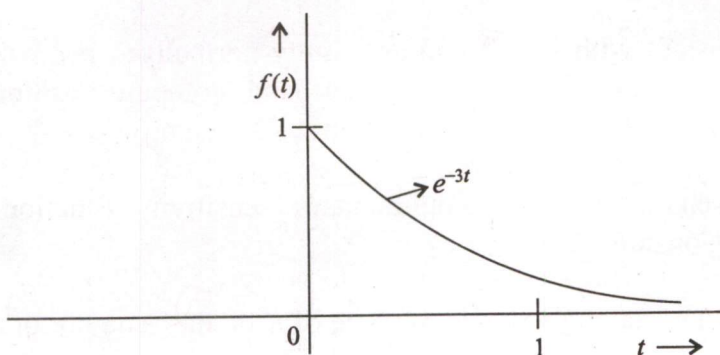

12

- 5.(b) A step-down DC-DC converter is feeding an RLE load with a freewheeling diode across the load. Assuming a ripple free load current, derive the expression for maximum duty cycle in terms of supply voltage  $V_S$  and back emf of the load  $E$  for which the RMS current through the freewheeling diode has maximum value. 12

- 5.(c) The block diagram of a system is as shown below. Find the overall transfer function of the system using block diagram reduction technique. 12

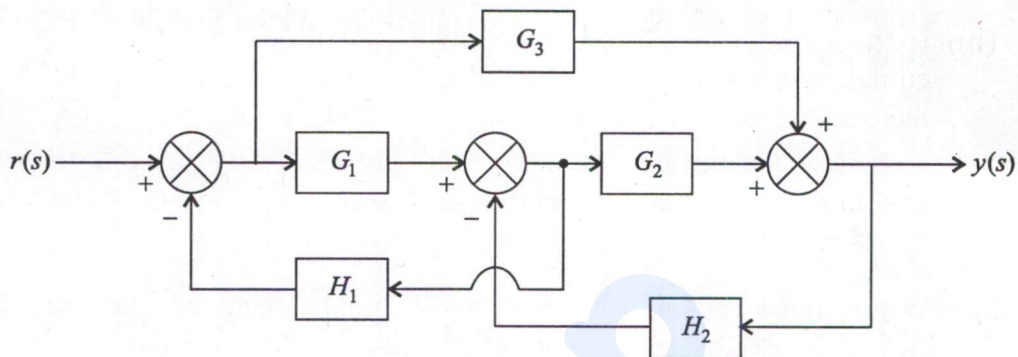

- 5.(d) (i) Draw the silicon cross-section view of IGBT and identify the distinguishing feature from MOSFET with reference to the conductivity modulation. Also, state its impact on IGBT operation and performance. 8
- (ii) Draw 2-transistor and simplified equivalent circuits with proper labels and their significance. 4
- 5.(e) The overall transfer function of a unity feedback system is given by

$$G_{CL}(S) = \frac{Ks + b}{s^2 + as + b}$$

- (i) Calculate the open loop transfer function of the system and its type.
- (ii) If the overall system with  $K = 0$ , admits a unity normalized bandwidth, and a settling time of 4 seconds for 2% tolerance band, compute position, velocity and acceleration error constants. Assume unity DC gain.
- (iii) Compute the sensitivity and complimentary sensitivity function value at  $\omega = 1$  rad/sec. Consider  $K = 1$ .
- (iv) Discuss the effect of having a non-zero value of  $K$  on the behavior of the system in comparison to that with  $K = 0$ . 12

- 6.(a) A single phase AC controller operating on phase control is supplied from a 230 V, 50 Hz AC supply. If the controller is feeding a purely resistive load of  $10 \Omega$  at a firing angle of  $45^\circ$ ; then determine
- the RMS output voltage  $V_{0, \text{rms}(\text{phase})}$  of the phase controlled AC controller.
  - the equivalent duty cycle ( $K$ ) of an integral cycle AC controller that would produce the same RMS output voltage.
  - If the integral cycle controller operates with a total of 100 cycles for one complete operation, determine the number of 'ON' cycles and 'OFF' cycles for the same as in (ii).
  - The input power factor of the integral duty cycle AC controller operating at equivalent duty cycle.
  - The RMS Thyristor current  $I_{T, \text{rms}}$  for the integral cycle controller operating at this equivalent duty cycle.

Derive the formula used for integral cycle AC controllers as used in above parts. 20

- 6.(b)(i) Derive the even and odd decomposition of a general signal  $x(t)$  by applying the definitions of even and odd signals. 10
- 6.(b)(ii) Find Fourier Transform of  $x(t)$ , which is given by following rectangular pulse, as shown in figure. 10

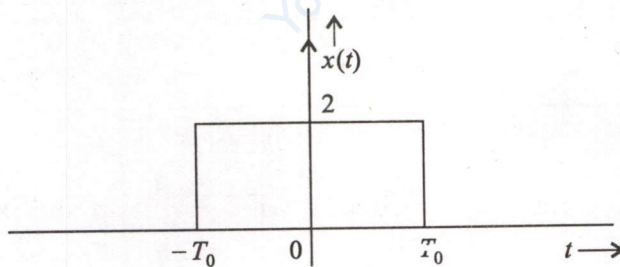

- 6.(c) A unity feedback system has open loop transfer function

$$G(s) = \frac{K \cdot e^{-0.5s}}{(s^2 + \alpha s + \beta)}$$

$G(s)$  has a DC gain of  $K/16$ , and has a decay rate of 2 nepers per second. Using first-order Pade approximation for the delay, sketch the root locus plot of  $G(s)$  and find the range of  $K$  for which the unity feedback system remains stable. 20

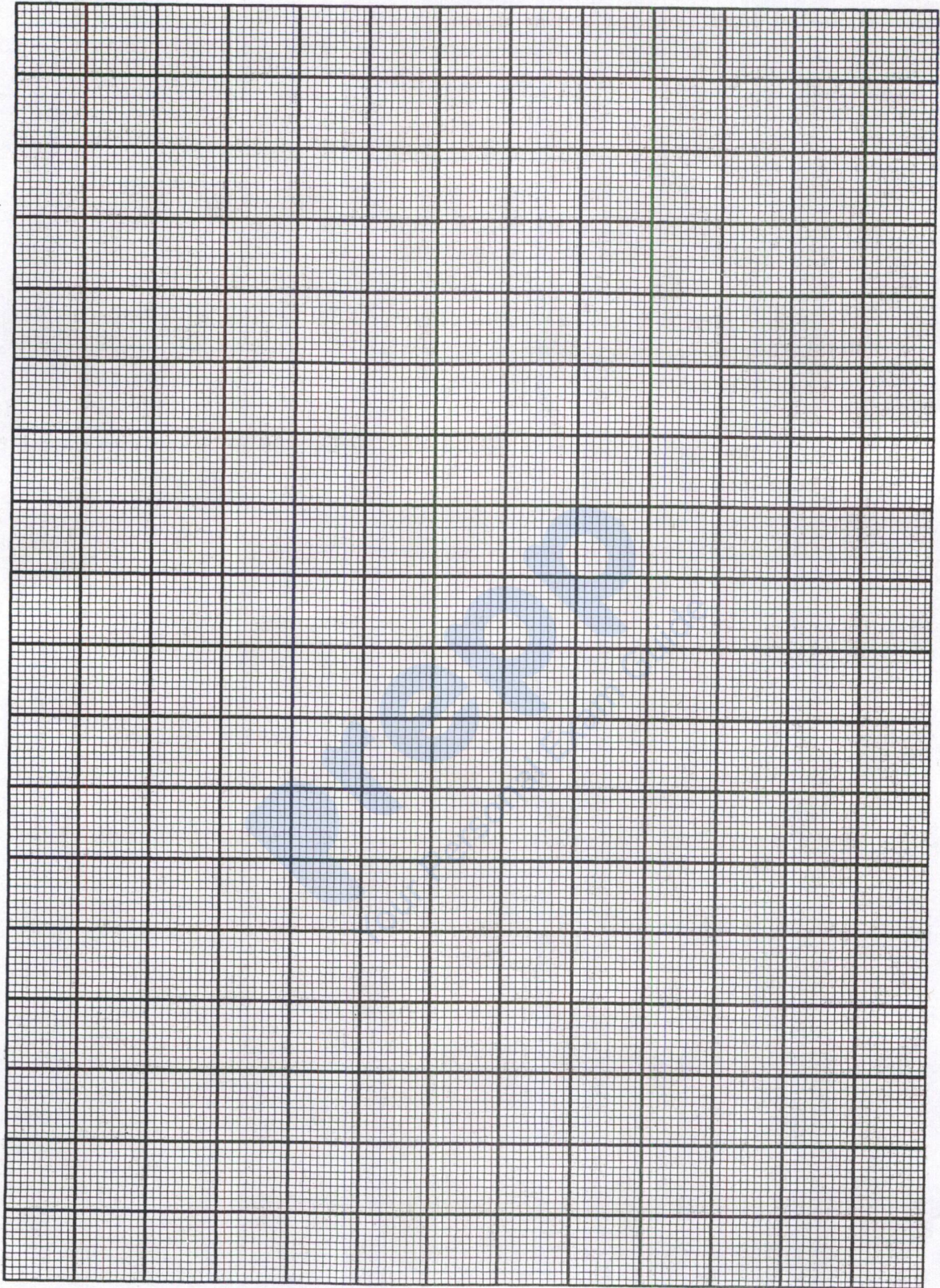

- 7.(a) A second order system  $G_1(s)$  as shown in figure

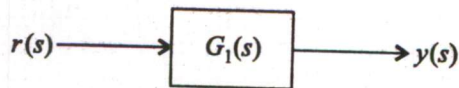

has no zeros, and has unity DC gain.

The unit step response of  $G_1(s)$  has a decay rate of 2.5 nepers/sec and has undamped natural frequency of  $\sqrt{6}$  rad/sec.

- (i) Compute the observable canonical state space representation of  $G_1(s)$  and obtain its state transition matrix using Cayley-Hamilton approach.
- (ii) Now another identical  $G_1(s)$  is placed in cascade with earlier  $G_1(s)$ , as shown below.



Obtain the state space representation of overall cascaded system using previously computed observable canonical representation of  $G_1(s)$ .

20

- 7.(b) A buck converter with RC filter is shown in figure below with a load resistance  $R_L$ .

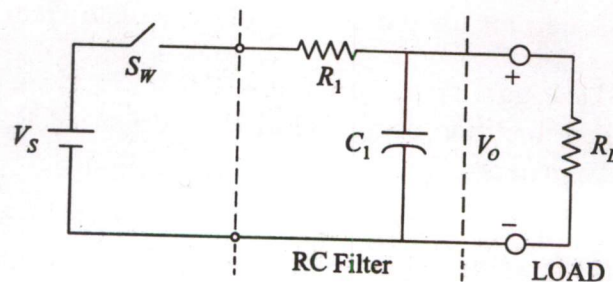

The switch  $S_W$  is operated with  $DT_S$  time ON and  $(1-D) T_S$  time OFF, cyclically with a time period of  $T_S$ . Draw the relevant waveforms and derive the expression for output voltage  $V_o$  as a function of duty ratio 'D'. Assume the switching frequency to be high.

20

7.(c) Consider a signal  $x(t)$  shown in following figure. Sketch and describe mathematically the signal  $x(t)$ .

(i) If time-compressed by factor 5.

(ii) Repeat the problem for same signal time-expanded by factor 3.

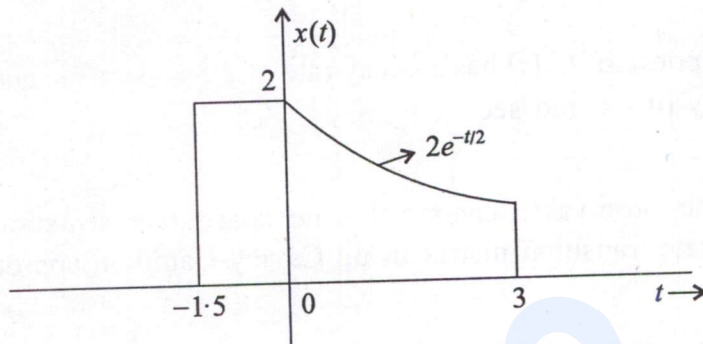

10+10

8.(a) Find the solution of following second order differential equation by using Laplace Transform Method. The differential equation is

$$\frac{d^2 y(t)}{dt^2} + 7 \frac{dy(t)}{dt} + 12y(t) = \frac{dx(t)}{dt} + x(t)$$

with initial conditions  $y(0^-) = 2$  and  $\dot{y}(0^-) = 1$  and  $x(t) = e^{-5t}u(t)$  and  $x(0^-) = 0$ . 20

8.(b) The open-loop transfer function of a unity feedback system is given as

$$G(s) = \frac{10}{(s-1)(s+5)}$$

Sketch the Bode plot for the system and calculate Gain and Phase margins. 20

8.(c) Design a UJT triggering circuit for a 220 V, 50 Hz a.c. source fed single phase half controlled rectifier using BT 151 – 500 R SCR and 2N2646 UJT having following parameters :

$$\begin{aligned} 2N2646 \text{ UJT} : \eta &= 0.65, R_{BB} = 7 \text{ k}\Omega, I_P = 5 \mu\text{A}, V_V = 3 \text{ V}, I_V = 4 \text{ mA}, \\ \text{BT 151 - 500 R SCR} : V_{GT} &= 0.8 \text{ V (typical), } 1.5 \text{ V(max)} \\ I_{GT} &= 5 \text{ mA (typical), } 15 \text{ mA} \\ V_{DRM} &= 500 \text{ V.} \end{aligned}$$

Assume the triggering circuit be fed from 24 V DC.

Take  $V_{BB}$  of 20 V for design and pulse width of triggering pulse of 30  $\mu\text{s}$ .  
Draw relevant circuits and show the component values with power ratings. 20

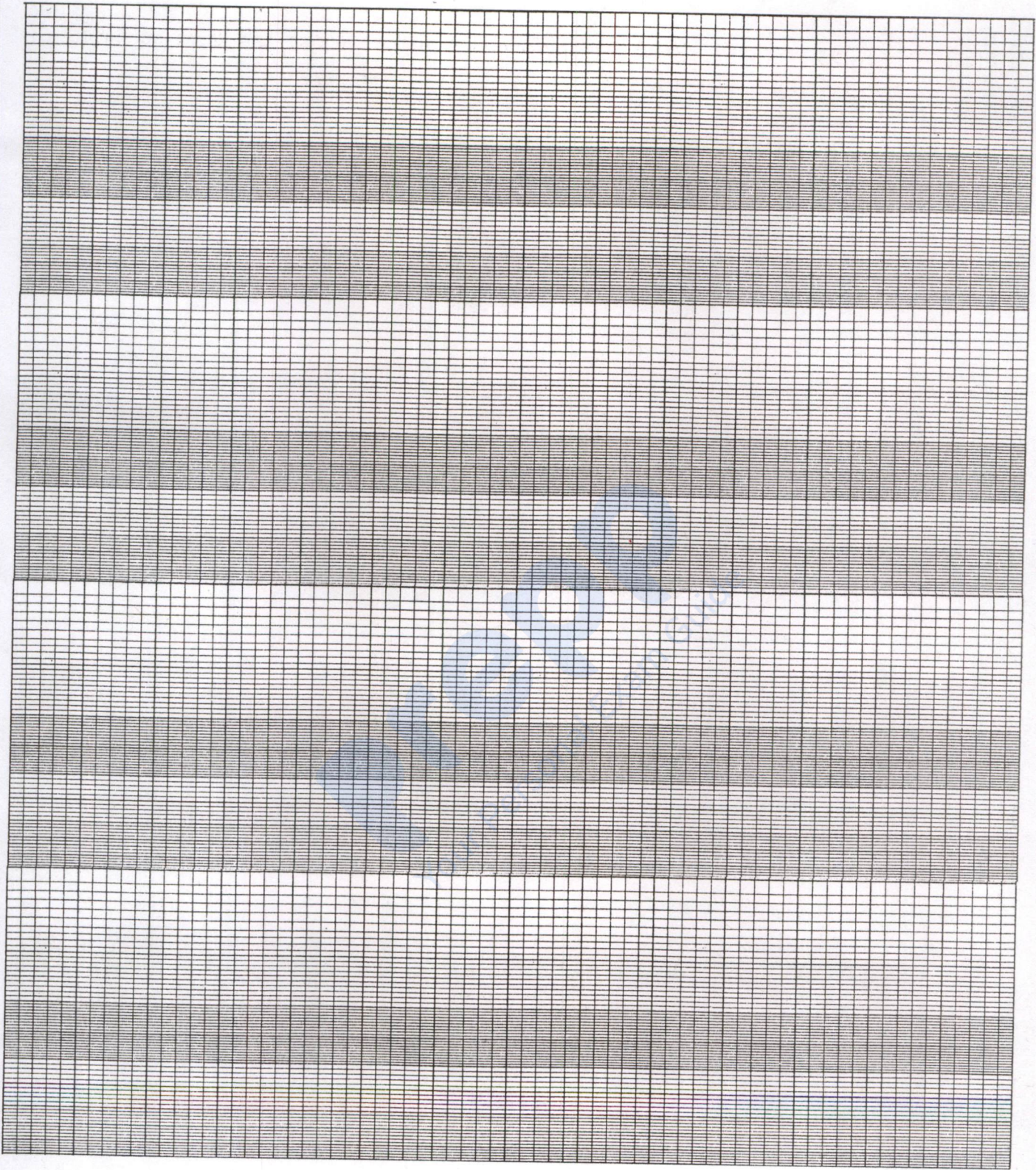

**prepp**  
Your Personal Exam Guide